

CITY OF VINELAND

December 19, 2017

REPORT TO: THE MAYOR AND COUNCIL

RE: Street Lighting Recommendations December 2017

Dear Mayor and Members of Council:

Submitted to you herewith are requests for street lighting improvements which are ready for your approval. Copies of the recommendations of the City of Vineland Electric Utility with respect to these requests, along with copies of the drawings identifying the areas in question, are attached for your review.

Should you have any questions pertaining to this matter, please do not hesitate to contact this office.

Respectfully submitted,

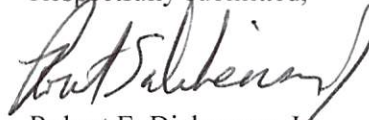

Robert E. Dickenson, Jr.
Business Administrator

/rl

Encls.

cc: John Lillie
Susan Baldosaro

Approved:

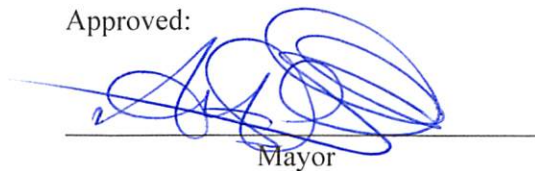

Mayor

12/14/2017

Date

CITY OF VINELAND

STREET LIGHTING RECOMMENDATIONS

DECEMBER 2017

REQUEST

RECOMMENDATIONS

1. Area of Butler Avenue
(between East Blvd & Lincoln Ave)
Drawing No. VMEU-2851
Upgrade one (1) existing street light to 54W LED, ten (10) 74W LED (relocating five (5) street lights), and four (4) 108W LED. Install five (5) additional 74W LED street lights onto existing utility poles.
2. Area of East Blvd
(between Weymouth Rd and Wheat Rd)
Drawing No. VMEU-2852
Upgrade eleven (11) existing street lights to 74W LED (relocating nine (9) street lights), and three (3) 108W LED. Install nine (9) additional 74W LED street lights onto existing utility poles.
3. Area of Hance Bridge Road
(between Panther Rd & Sherman Ave)
Drawing No. VMEU-2853
Upgrade fifteen (15) existing street lights to 74W LED, and five (5) to 108W LED. Install three (3) additional 74W LED street lights onto existing utility poles.

VINELAND MUNICIPAL ELECTRIC UTILITY
VINELAND, NEW JERSEY 08360



STREET LIGHT REQUEST

DATE: October 4, 2017

TO: Bob Dickenson
Business Administrator

PROPOSED BY:

RE: Survey at : Area of Butler Ave.
between East Blvd. and Lincoln Ave.

NAME: John T. Boyle

ADDRESS: VMU

The preceding-mentioned location has been surveyed by VMU to ensure proper street lighting in conformance with standard City practice. As a result, we propose the following enhancement(s):

PROPOSED: Upgrade one (1) existing street light to 54W LED, ten (10) 74W LED (relocating five street lights), and four (4) 108 W LED. Install five (5) additional 74W LED st. lt. onto existing utility poles.

Yours truly,

Approved by :

John T. Boyle, Jr.
Assistant General Manager
Vineland Municipal Utilities

Attachments: DWG.#VMEU-2851

VINELAND MUNICIPAL ELECTRIC UTILITY
VINELAND, NEW JERSEY 08360



STREET LIGHT REQUEST

DATE: October 24, 2017

TO: Bob Dickenson 
Business Administrator

PROPOSED BY:

RE: Survey at : Area of East Blvd.
between Weymouth Rd. and Wheat Rd.

NAME: John T. Boyle

ADDRESS: VMU

The preceding-mentioned location has been surveyed by VMU to ensure proper street lighting in conformance with standard City practice. As a result, we propose the following enhancement(s):

PROPOSED: Upgrade eleven (11) existing street lights to 74W LED (relocating nine (9) street lights), and three (3) 108W LED. Install nine (9) additional 74W LED st. lt. onto existing utility poles.

Yours truly,

Approved by :

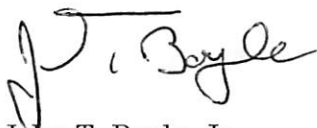
John T. Boyle, Jr.
Assistant General Manager
Vineland Municipal Utilities

Attachments: DWG.#VMEU-2852

VINELAND MUNICIPAL ELECTRIC UTILITY
VINELAND, NEW JERSEY 08360



STREET LIGHT REQUEST

DATE: November 8, 2017

TO: Bob Dickenson 
Business Administrator

PROPOSED BY:

RE: Survey at : Area of Hance Bridge Rd. NAME: John T. Boyle
between Panther Rd. and Sherman Ave.

ADDRESS: VMU

The preceding-mentioned location has been surveyed by VMU to ensure proper street lighting in conformance with standard City practice. As a result, we propose the following enhancement(s):

PROPOSED: Upgrade fifteen (15) existing street lights to 74W LED, and five (5) to 108W LED.

Install three (3) additional 74W LED street lights onto existing utility poles.

Yours truly,



Approved by :

John T. Boyle, Jr.
Assistant General Manager
Vineland Municipal Utilities

Attachments: DWG.#VMEU-2853

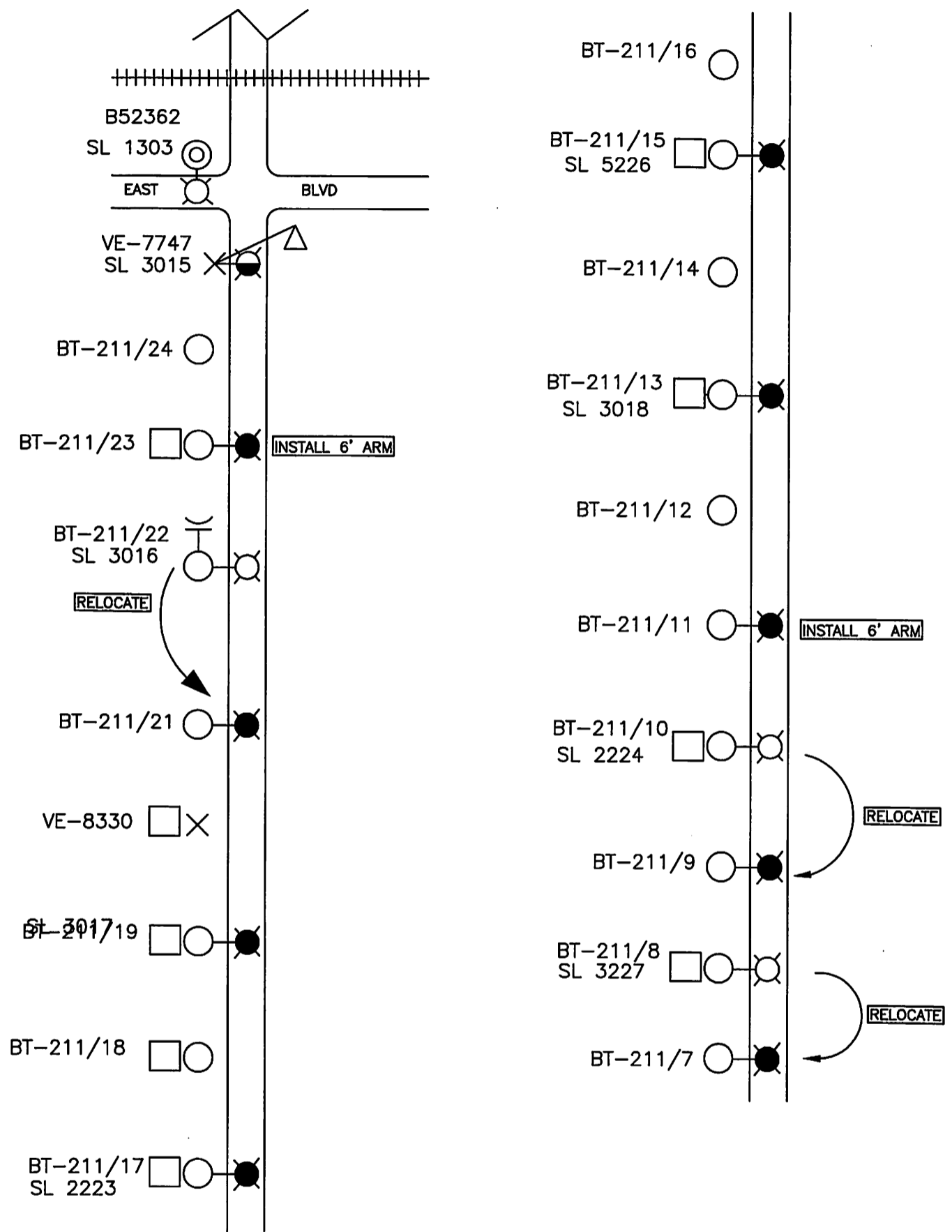

SHEET 1 OF 3

	EXISTING SL REMAIN AS IS
	INSTALL/REPLACE W/ (1) 54W LED
	INSTALL/REPLACE W/ (20) 74W LED
	INSTALL/REPLACE W/ (4) 108W LED

PROPOSED STREET LIGHT REVISION BUTLER AVE BETWEEN EAST BLVD. AND LINCOLN AVE.	
VINELAND MUNICIPAL ELECTRIC UTILITY VINELAND, NEW JERSEY	
DRAWN: EHS	VAULT # F-3-C
DATE: 10/4/2017	DRAWING # VMEU-2851
SCALE: NTS	CHECKED:



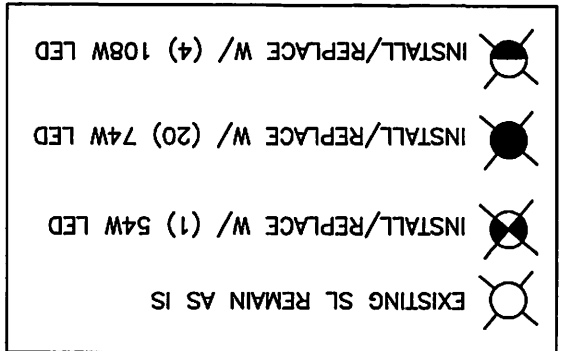

SCALE: NTS		CHECKED:
DATE: 10/4/2017		DRAWING # VMEU-2851
DRAWN: EHS		VAULT # F-3-C
VINELAND MUNICIPAL ELECTRIC UTILITY		
VINELAND, NEW JERSEY		
PROPOSED STREET LIGHT REVISION		
BUTLER AVE. BETWEEN EAST BLVD. AND LINCOLN AVE.		

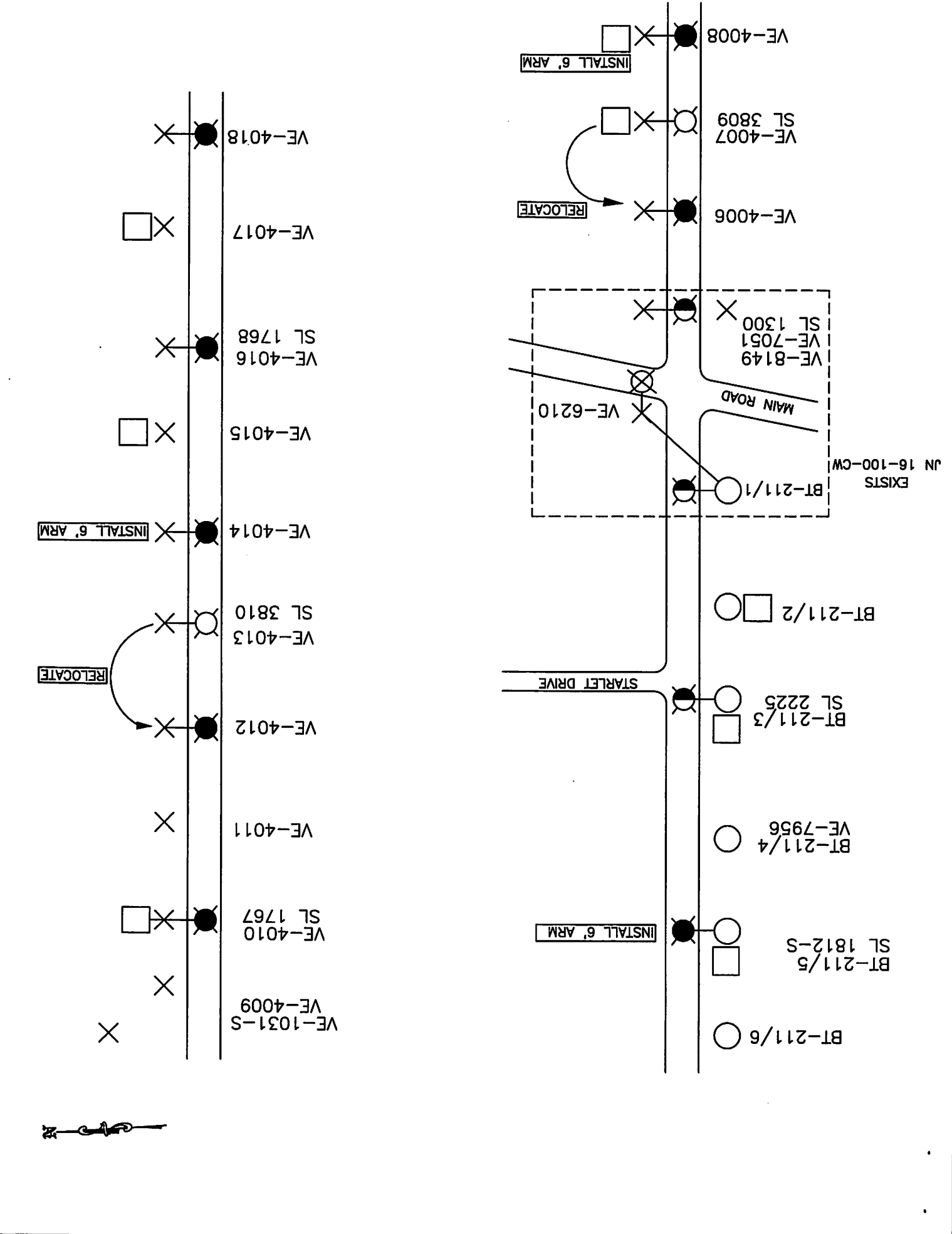

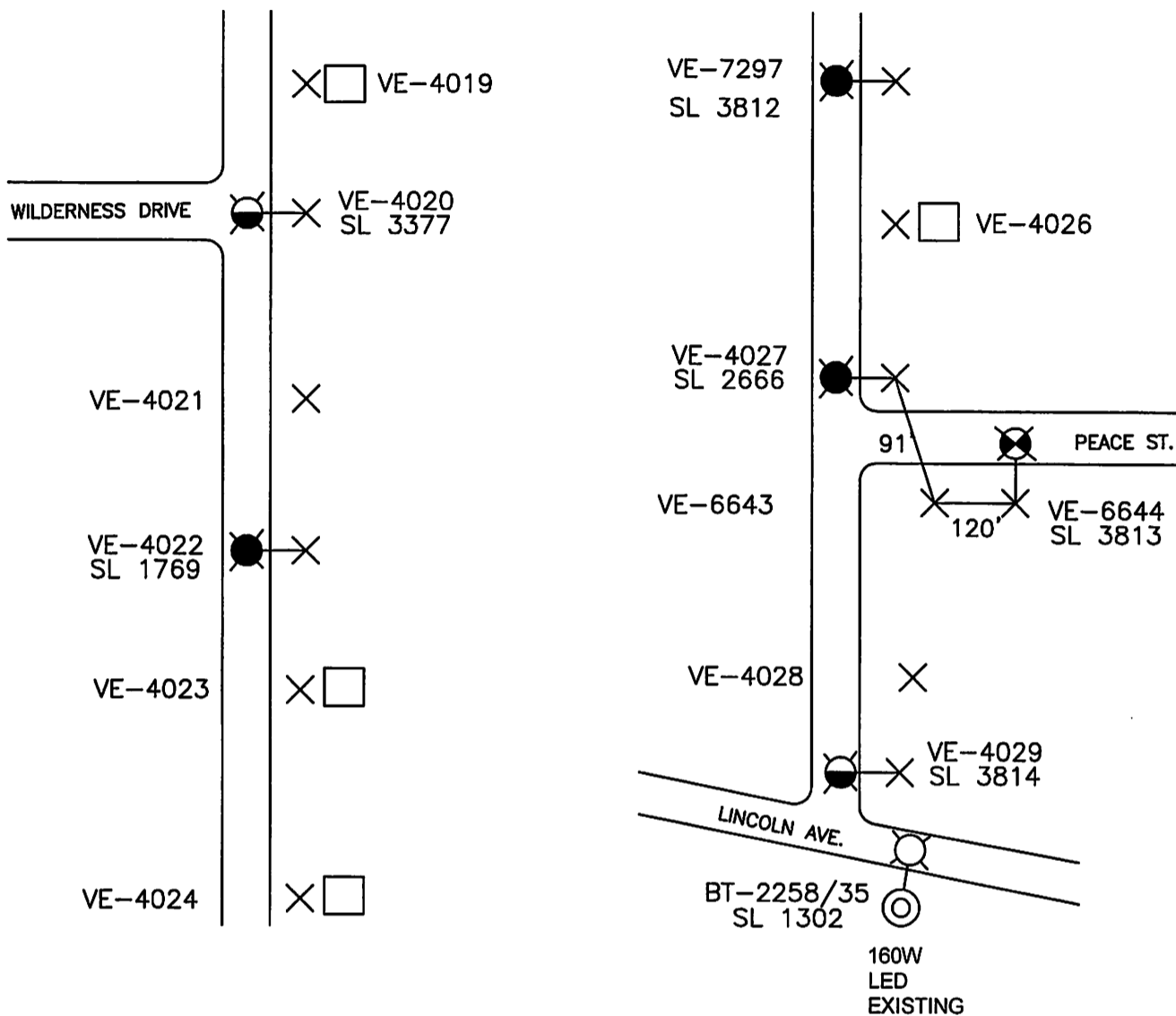
SHEET 2 OF 3





	EXISTING SL REMAIN AS IS
	INSTALL/REPLACE W/ (1) 54W LED
	INSTALL/REPLACE W/ (20) 74W LED
	INSTALL/REPLACE W/ (4) 108W LED

PROPOSED STREET LIGHT REVISION BUTLER AVE. BETWEEN EAST BLVD. AND LINCOLN AVE.	
VINELAND MUNICIPAL ELECTRIC UTILITY VINELAND, NEW JERSEY	
DRAWN: EHS	VAULT # F-3-C
DATE: 10/4/2017	DRAWING # VMEU-2851
SCALE: NTS	CHECKED: 

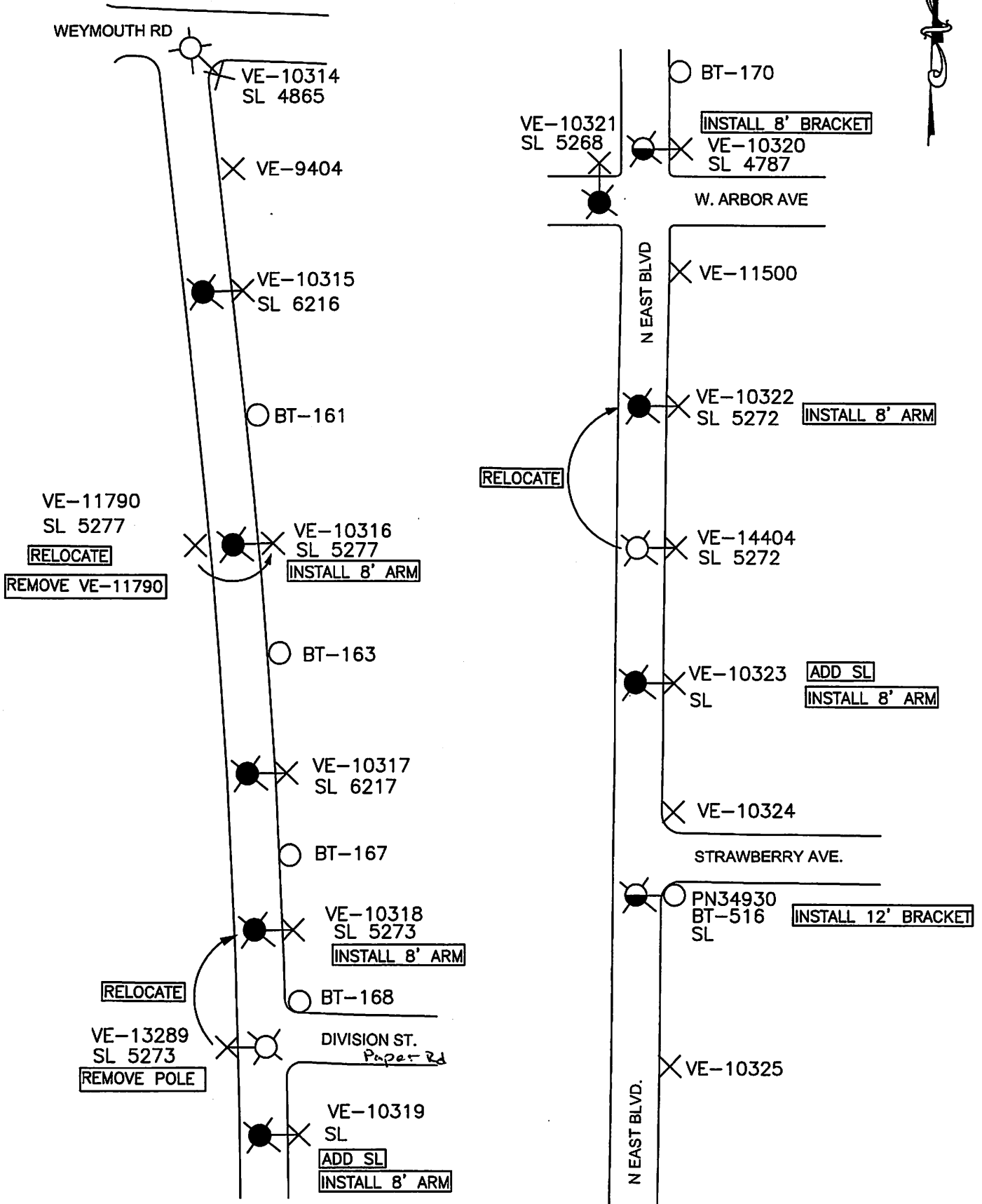

SHEET 1 OF 4

KEY	
	EXISTING SL REMAIN AS IS
	INSTALL/REPLACE W/ (8) 74W LED
	INSTALL/REPLACE W/ (2) 108W LED

PROPOSED STREET LIGHT REVISION AREA OF EAST BLVD BETWEEN WEYMOUTH ROAD AND WHEAT ROAD	
VINELAND MUNICIPAL ELECTRIC UTILITY VINELAND, NEW JERSEY	
DRAWN: EHS	VAULT # F-3-C
DATE: 10/24/2017	DRAWING # VMEU-2852
SCALE: NTS	CHECKED: <i>[Signature]</i>

1947
1948
1949
1950
1951
1952
1953
1954
1955
1956
1957
1958
1959
1960
1961
1962
1963
1964
1965
1966
1967
1968
1969
1970
1971
1972
1973
1974
1975
1976
1977
1978
1979
1980
1981
1982
1983
1984
1985
1986
1987
1988
1989
1990
1991
1992
1993
1994
1995
1996
1997
1998
1999
2000
2001
2002
2003
2004
2005
2006
2007
2008
2009
2010
2011
2012
2013
2014
2015
2016
2017
2018
2019
2020
2021
2022
2023
2024
2025

1947
1948
1949
1950
1951
1952
1953
1954
1955
1956
1957
1958
1959
1960
1961
1962
1963
1964
1965
1966
1967
1968
1969
1970
1971
1972
1973
1974
1975
1976
1977
1978
1979
1980
1981
1982
1983
1984
1985
1986
1987
1988
1989
1990
1991
1992
1993
1994
1995
1996
1997
1998
1999
2000
2001
2002
2003
2004
2005
2006
2007
2008
2009
2010
2011
2012
2013
2014
2015
2016
2017
2018
2019
2020
2021
2022
2023
2024
2025

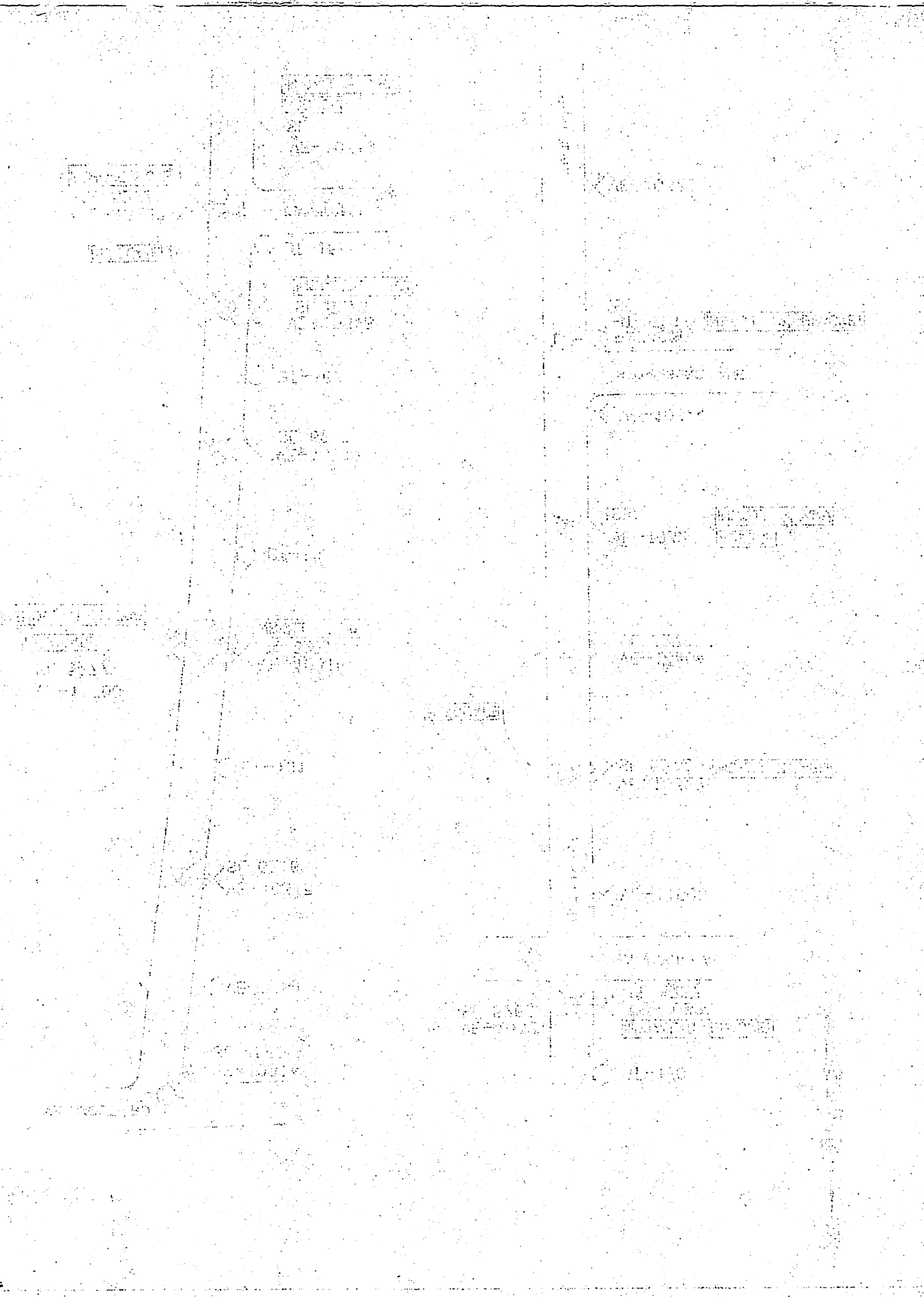

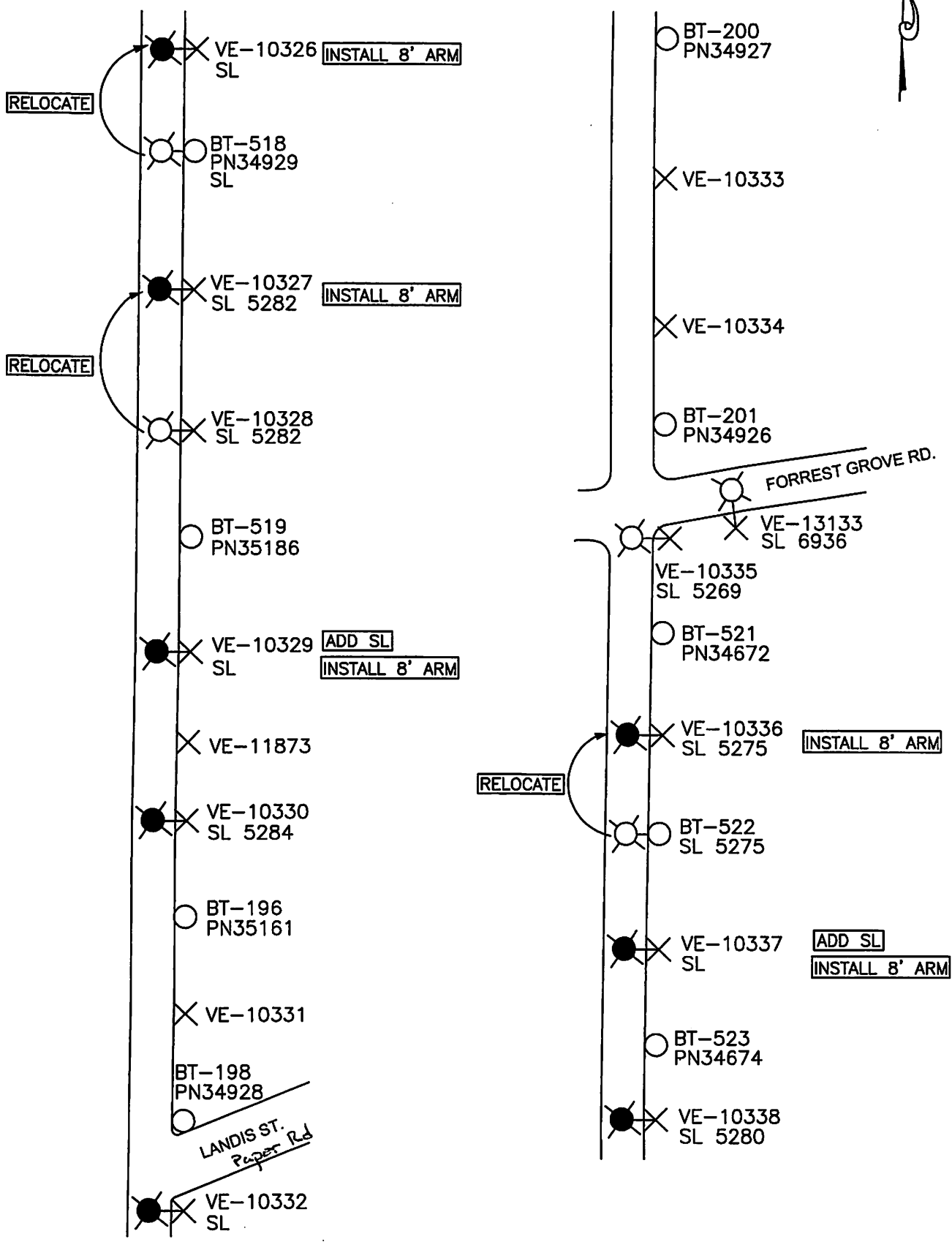

SHEET 2 OF 4

KEY	
	EXISTING SL REMAIN AS IS
	INSTALL/REPLACE W/ (8) 74W LED

PROPOSED STREET LIGHT REVISION AREA OF WEST BLVD BETWEEN CHESTNUT AVENUE AND GRANT AVENUE	
VINELAND MUNICIPAL ELECTRIC UTILITY VINELAND, NEW JERSEY	
DRAWN: EHS	VAULT # F-3-C
DATE: 10/24/2017	DRAWING # VMEU-2852
SCALE: NTS	CHECKED: <i>A.B.</i>

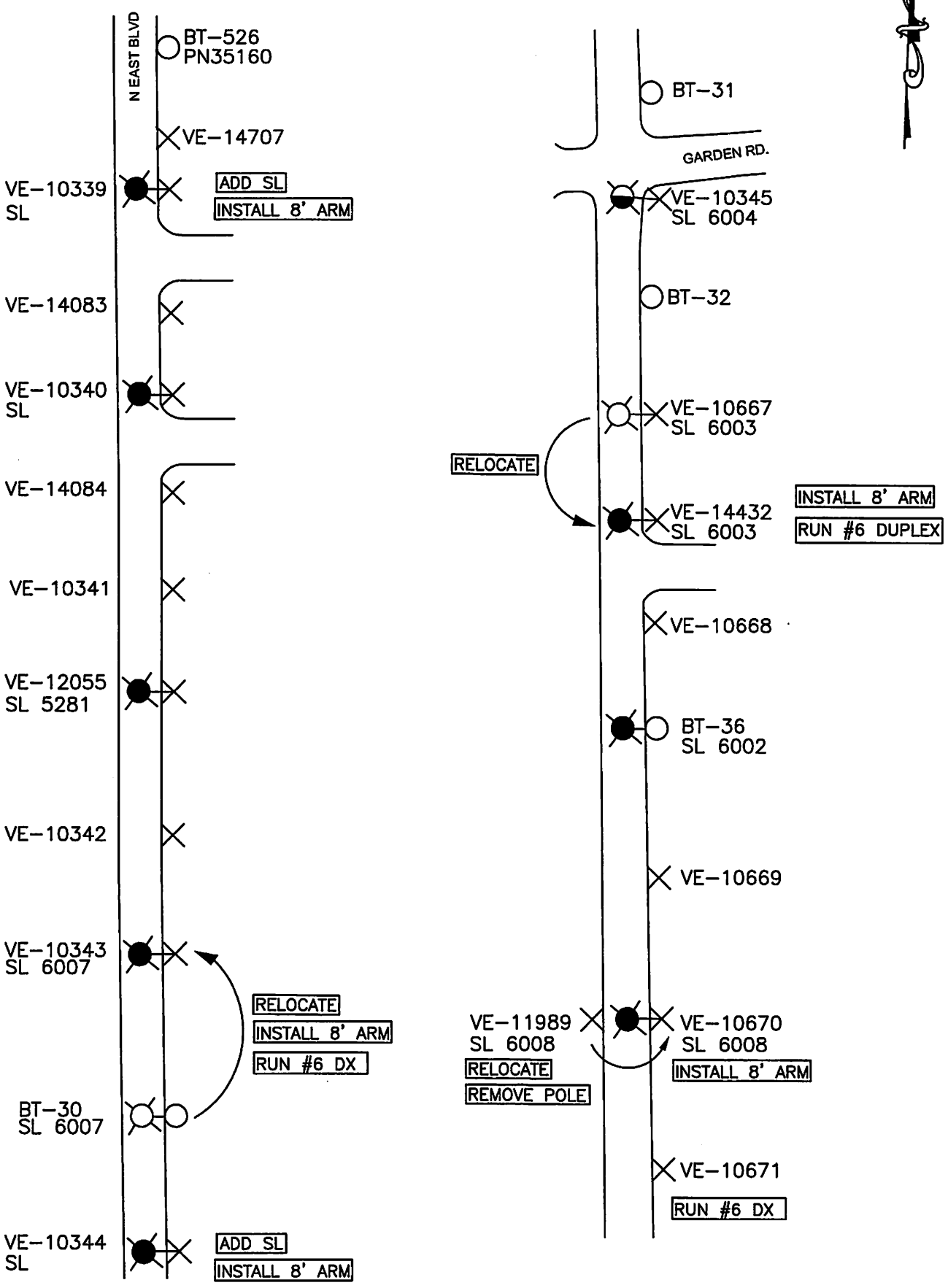

SHEET 3 OF 4

KEY	
	EXISTING SL REMAIN AS IS
	INSTALL/REPLACE W/ (8) 74W LED
	INSTALL/REPLACE W/ (1) 108W LED

PROPOSED STREET LIGHT REVISION AREA OF WEST BLVD BETWEEN CHESTNUT AVENUE AND GRANT AVENUE	
VINELAND MUNICIPAL ELECTRIC UTILITY VINELAND, NEW JERSEY	
DRAWN: EHS	VAULT # F-3-C
DATE: 10/24/2017	DRAWING # VMEU-2852
SCALE: NTS	CHECKED:

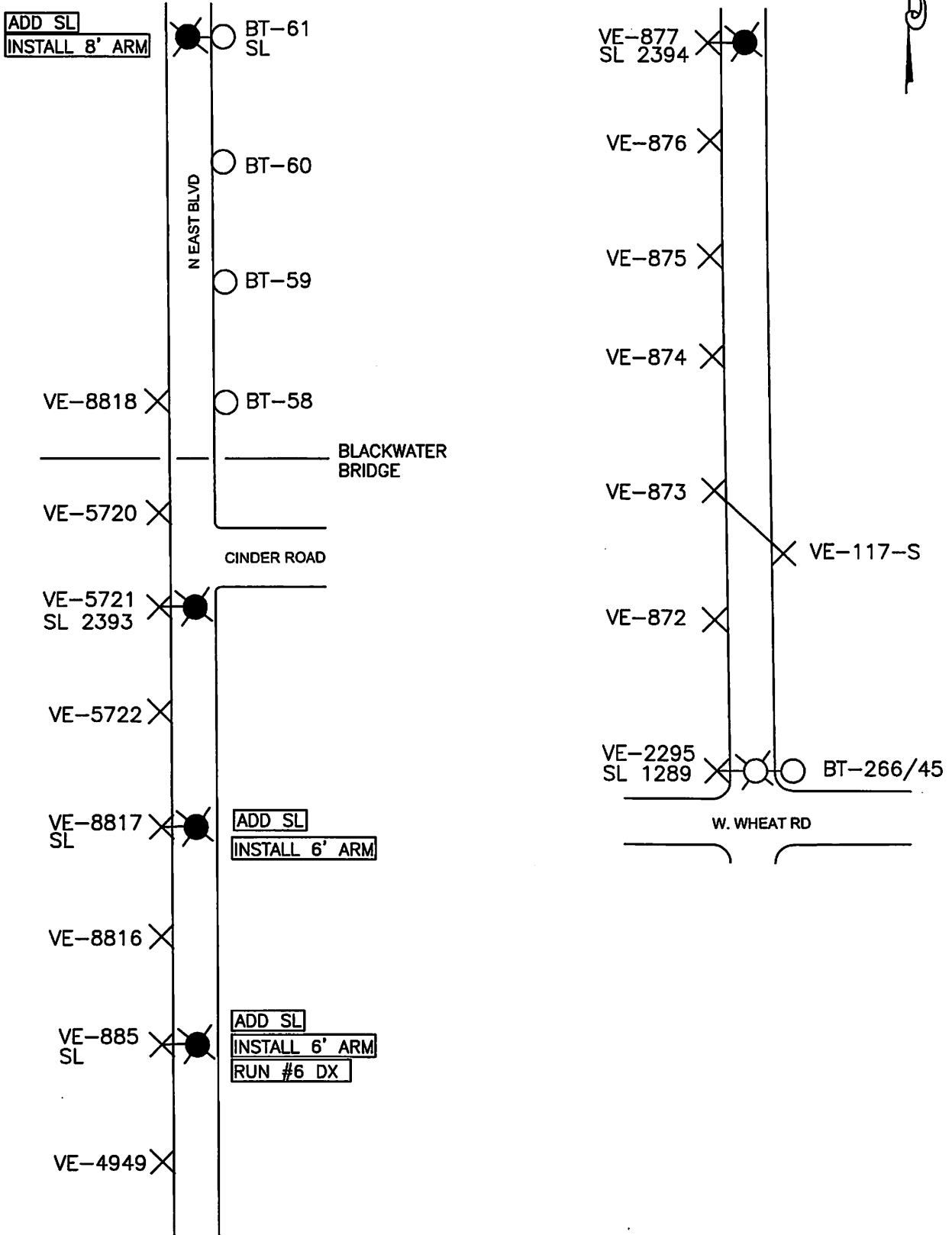

SHEET 4 OF 4

KEY	
	EXISTING SL REMAIN AS IS
	INSTALL/REPLACE W/ (5) 74W LED

PROPOSED STREET LIGHT REVISION AREA OF WEST BLVD BETWEEN CHESTNUT AVENUE AND GRANT AVENUE	
VINELAND MUNICIPAL ELECTRIC UTILITY VINELAND, NEW JERSEY	
DRAWN: EHS	VAULT # F-3-C
DATE: 10/24/2017	DRAWING # VMEU-2852
SCALE: NTS	CHECKED:

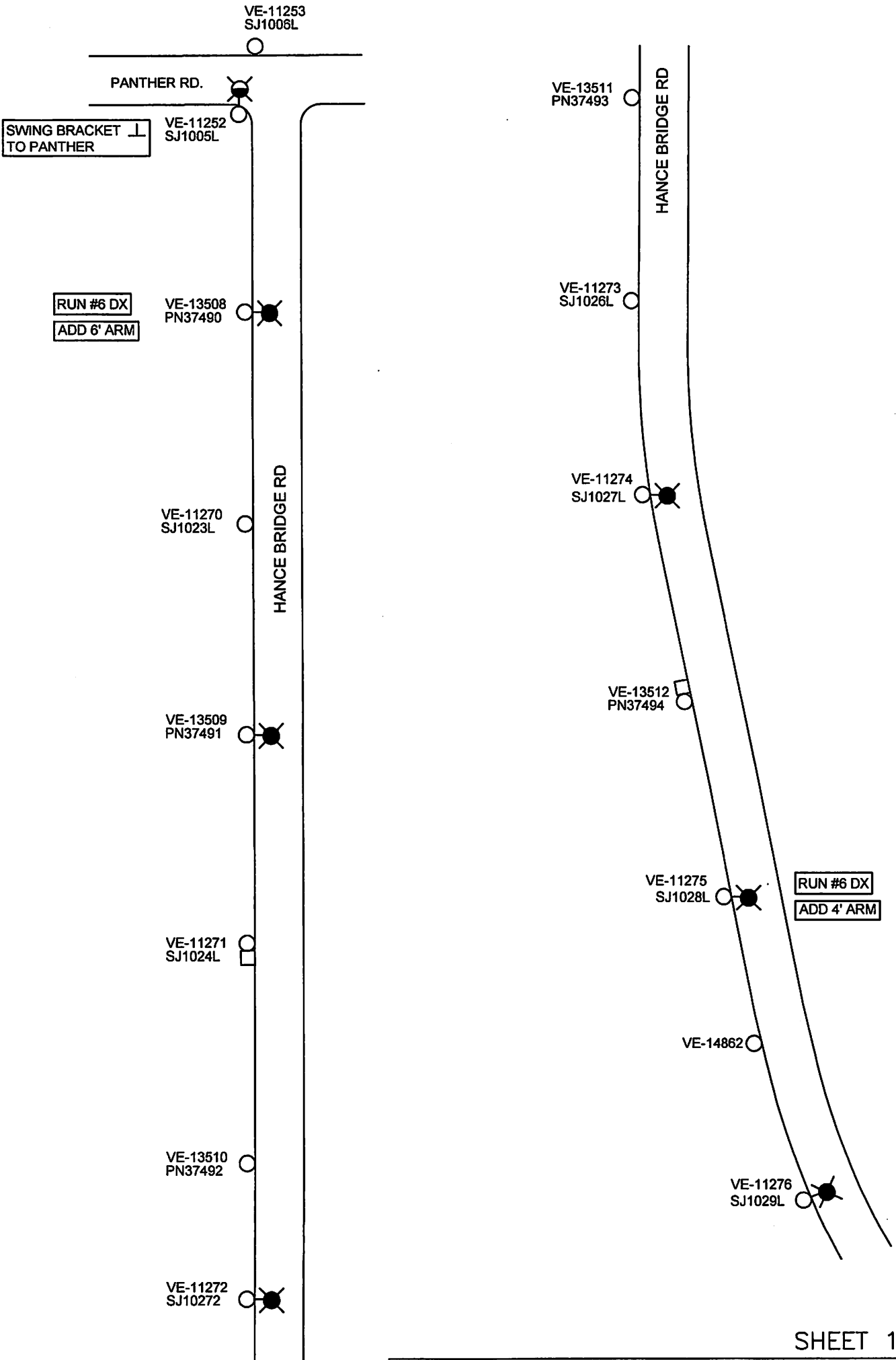

SHEET 1 OF 5

KEY	
	EXISTING SL REMAIN AS IS
	INSTALL/REPLACE W/ (6) 74 W LED
	INSTALL/REPLACE W/ (1) 108 W LED

PROPOSED STREET LIGHT REVISION HANCE BRIDGE RD. BETWEEN PANTHER RD AND SHERMAN AVE	
VINELAND MUNICIPAL ELECTRIC UTILITY VINELAND, NEW JERSEY	
DRAWN: EHS	VAULT # F-3-C
DATE: 11/8/2017	DRAWING # VMEU-2853
SCALE: NTS	CHECKED:

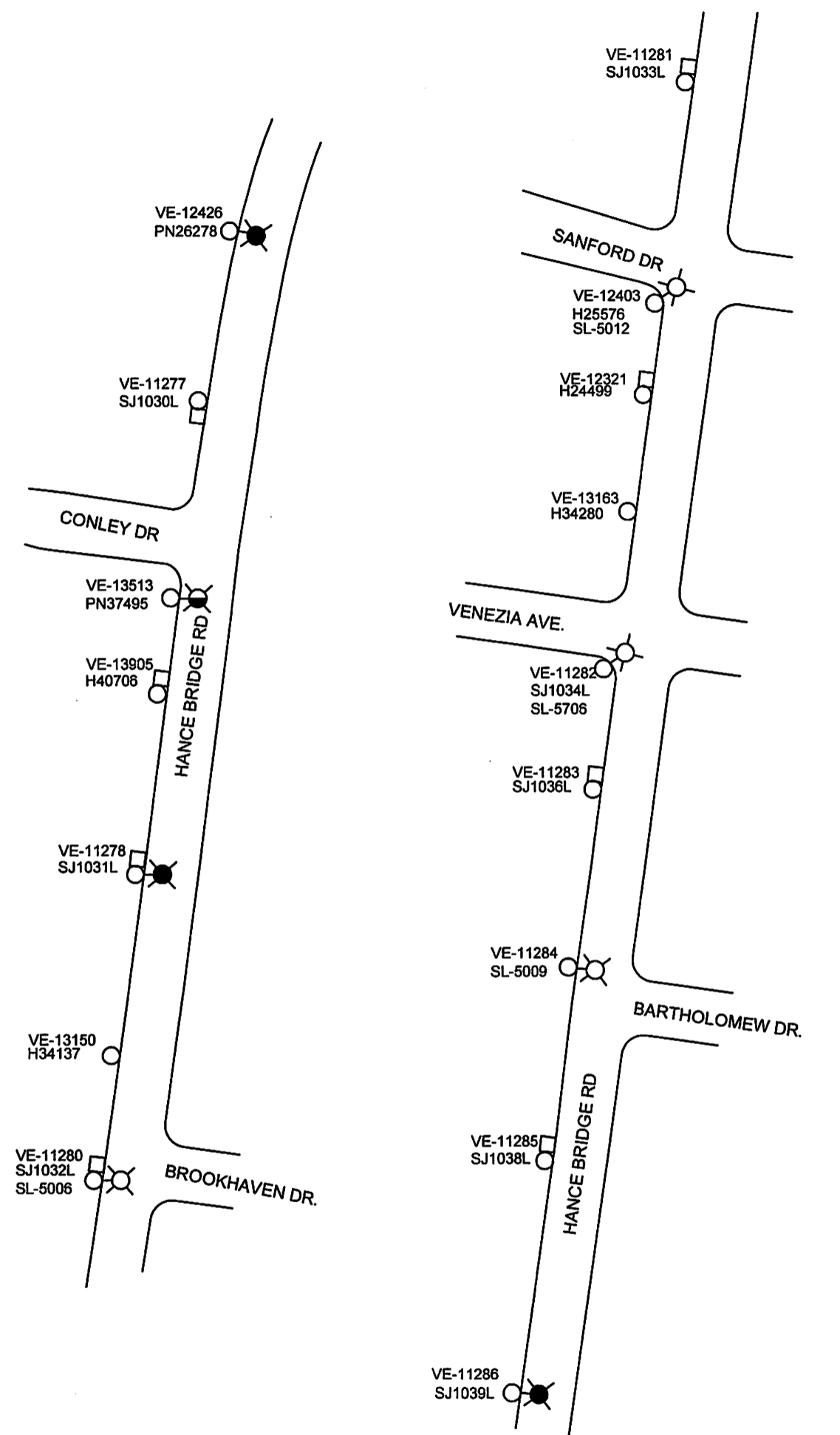

SHEET 2 OF 5

KEY	
	EXISTING SL REMAIN AS IS
	INSTALL/REPLACE W/ (3) 74 W LED
	INSTALL/REPLACE W/ (1) 108 W LED

PROPOSED STREET LIGHT REVISION	
HANCE BRIDGE RD. BETWEEN PANTHER RD AND SHERMAN AVE.	
VINELAND MUNICIPAL ELECTRIC UTILITY	
VINELAND, NEW JERSEY	
DRAWN: EHS	VAULT # F-3-C
DATE: 11/8/2017	DRAWING # VMEU-2853
SCALE: NTS	CHECKED:

SCALE: NTS		CHECKED: <i>[Signature]</i>
DATE: 11/8/2017		DRAWING # VMEU-2853
DRAWN: EHS		VAULT # F-3-C
VINELAND MUNICIPAL ELECTRIC UTILITY		
VINELAND, NEW JERSEY		
PROPOSED STREET LIGHT REVISION		
HANCE BRIDGE RD. BETWEEN PANTHER RD AND SHERMAN AVE.		

SHEET 3 OF 5

	EXISTING SL REMAIN AS IS
	INSTALL/REPLACE W/ (3) 74 W LED
	INSTALL/REPLACE W/ (2) 108 W LED

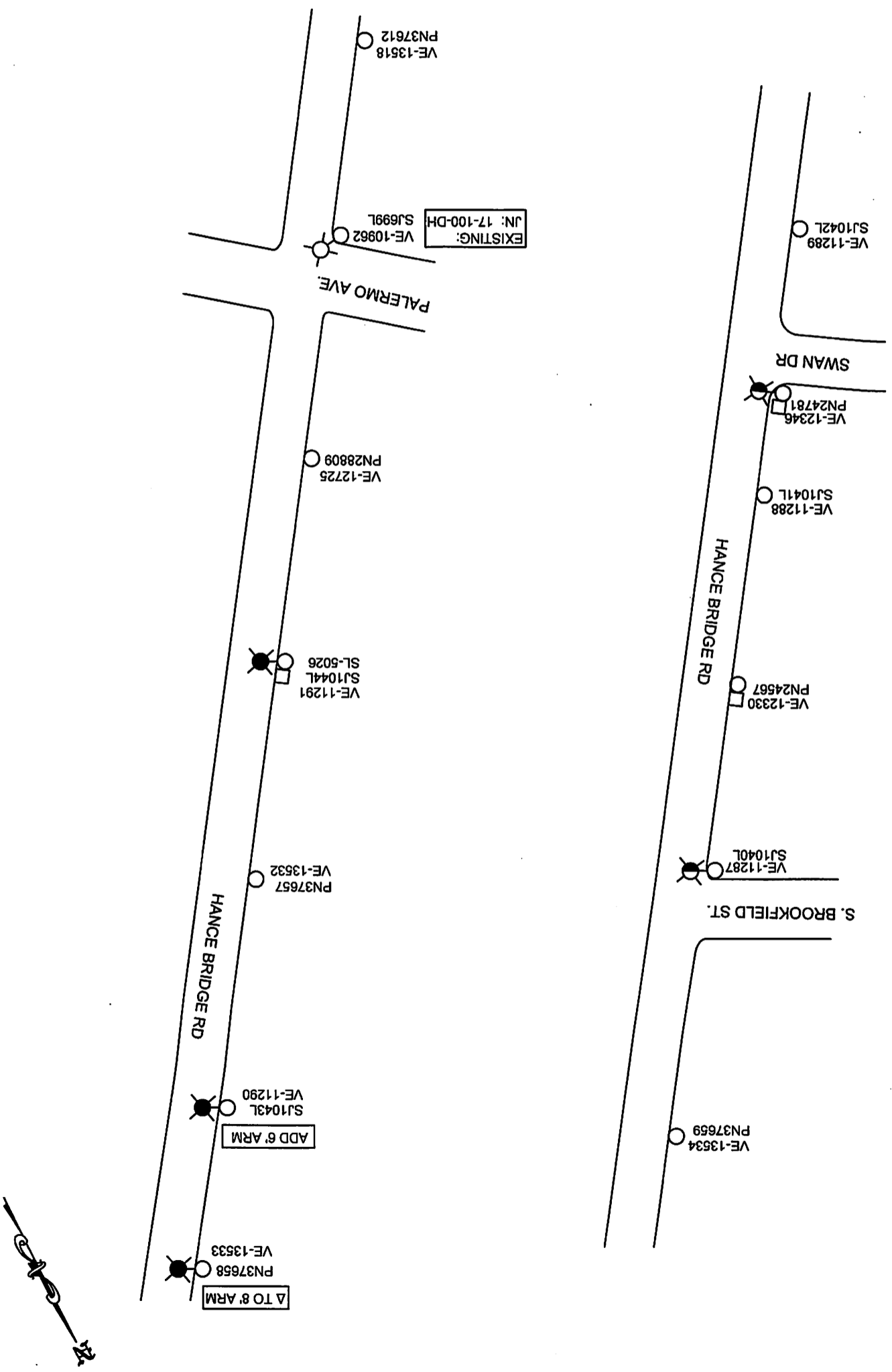

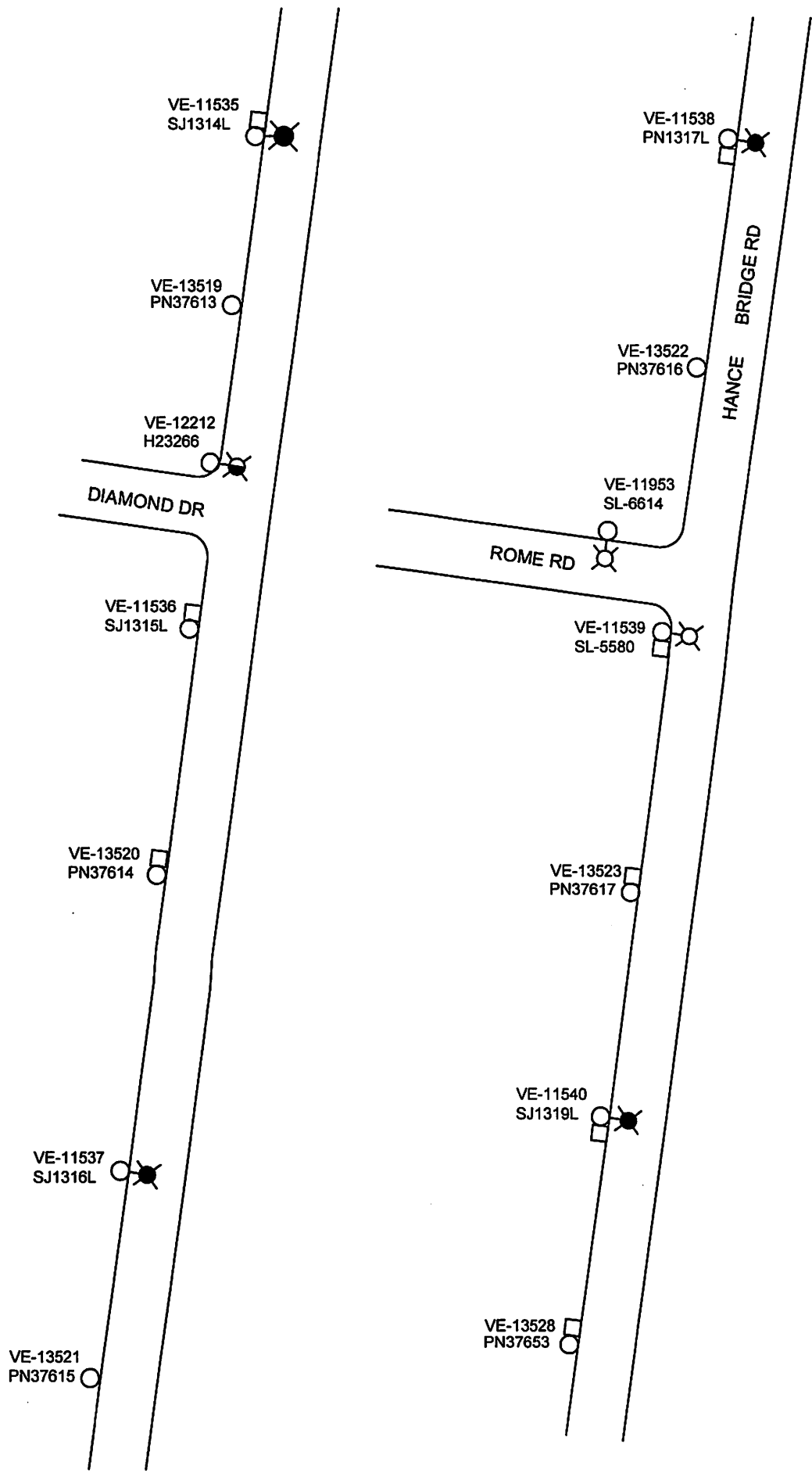

SHEET 4 OF 5

KEY	
	EXISTING SL REMAIN AS IS
	INSTALL/REPLACE W/ (4) 74 W LED
	INSTALL/REPLACE W/ (1) 108 W LED

PROPOSED STREET LIGHT REVISION	
HANCE BRIDGE RD. BETWEEN PANTHER RD AND SHERMAN AVE.	
VINELAND MUNICIPAL ELECTRIC UTILITY	
VINELAND, NEW JERSEY	
DRAWN: EHS	VAULT # F-3-C
DATE: 11/8/2017	DRAWING # VMEU-2853
SCALE: NTS	CHECKED: <i>AJB</i>

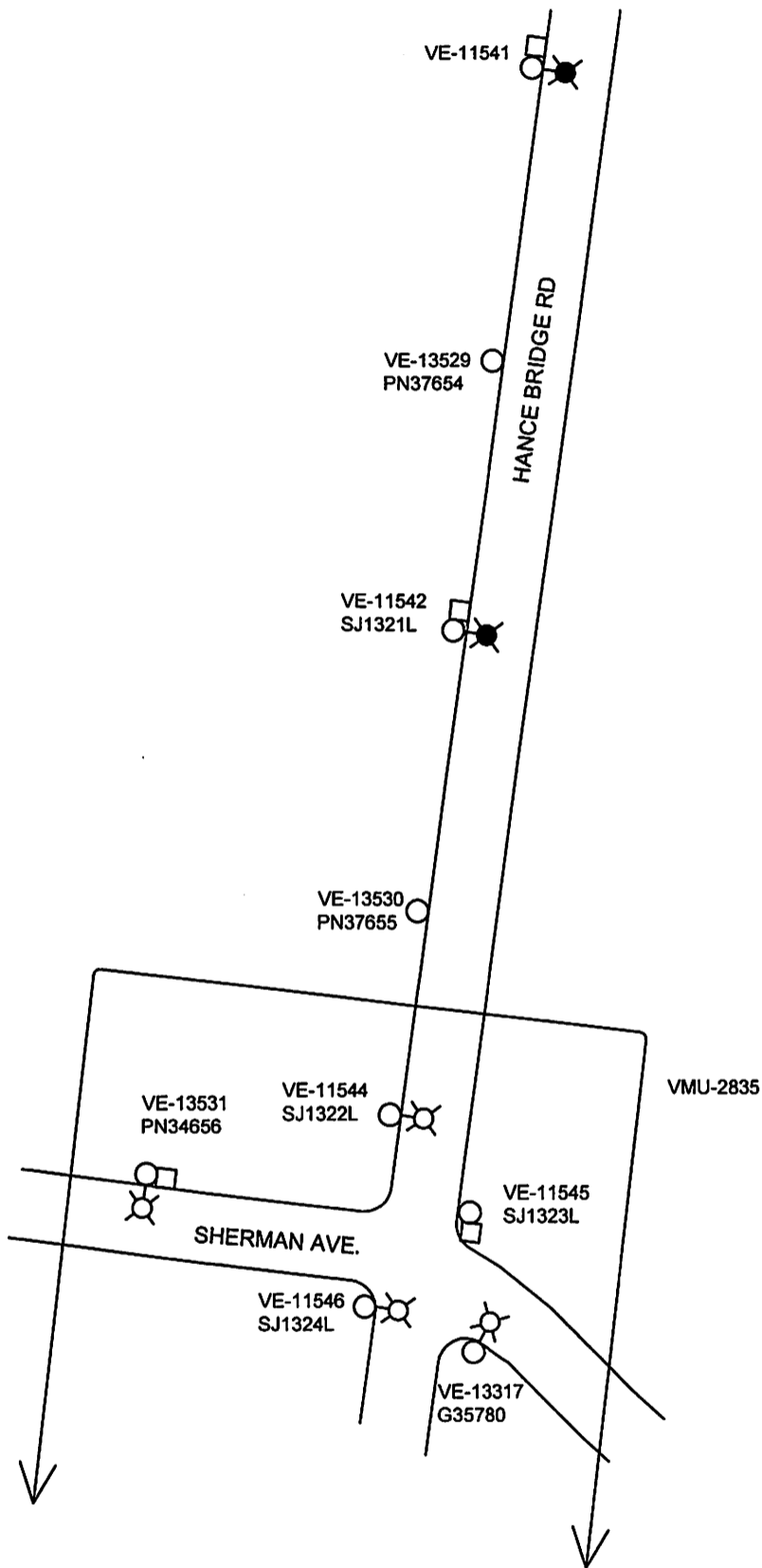

SHEET 5 OF 5

KEY	
	EXISTING SL REMAIN AS IS
	INSTALL/REPLACE W/ (2) 74 W LED

PROPOSED STREET LIGHT REVISION	
HANCE BRIDGE RD. BETWEEN PANTHER RD AND SHERMAN AVE.	
VINELAND MUNICIPAL ELECTRIC UTILITY	
VINELAND, NEW JERSEY	
DRAWN: EHS	VAULT # F-3-C
DATE: 11/8/2017	DRAWING # VMEU-2853
SCALE: NTS	CHECKED: