

CITY OF VINELAND

ORDINANCE NO. 2019-5

ORDINANCE AMENDING ORDINANCE 86-27, AS AMENDED, CHAPTER 239 OF THE CODE OF THE CITY OF VINELAND ENTITLED BICYCLES, SKATEBOARDS AND SIMILAR VEHICLES SO AS TO REQUIRE LIGHTS AND REFLECTIVE GEAR FOR THEIR SAFE OPERATION

WHEREAS, the New Jersey Department of Transportation and United States Department of Transportation Federal Highway Administration supports the use of bicycles as a means of personal transportation and recreation and encourage and support state, regional, county and local government agencies in the adoption of policies and the implementation of programs that will enhance the bicycling environment; and

WHEREAS, the State of New Jersey has adopted a bicycling manual to provide information required by bicyclists to ride on the roadways with other traffic and provide a basic understanding of how traffic and bicycles may safely interact; and

WHEREAS, City Council of the City of Vineland finds it in the best interest of the City to support the safe operation of bicycles, roller and inline skates and skateboards (non-motorized vehicles) on the roads and public parks within the City, and to assure that persons riding non-motorized vehicles are properly equipped to provide safe operation.

NOW, THEREFORE, BE IT ORDAINED by the City Council of the City of Vineland that Ordinance 86-27 as amended, chapter 239 of the Code of the City of Vineland entitled Bicycles, Skateboards and Similar Vehicles is amended as follows:

Section 239-3 shall be deleted in its entirety and replaced as follows:

239-3 Adoption of New Jersey Bicycling Manual

The City of Vineland hereby adopts the New Jersey Bicycling Manual to provide information required by bicyclists to ride on roadways and other public places within the City where such operation is permissible and incorporates the same herein by reference. The New Jersey Bicycling Manual shall be on file in the Office of the Clerk.

Section 239-4 shall be added as follows

239-4 Helmets required for persons under the age of 17

All persons under the age of 17 shall adhere to the requirement to wear helmets in accordance with N.J.S.A. 39:10.1. This requirement shall include the operation by persons under the age of 17 riding bicycles, roller and inline skates, skateboards and similar non-motorized vehicles.

Section 239-5 shall be added as follows:

Section 239-5 Reflective Gear

All persons under the age of 17 riding a bicycle, roller and inline skates, skateboards required to wear a helmet, shall wear a helmet which meets the standards of the American National Standards Institute, ANSI Z-90.4 bicycle helmet or Snell Memorial Foundation 1990 standard, as amended, for Protective Headgear of Use in Bicycling. In addition thereto, when riding after sundown and/or in the rain, said helmet shall be equipped with reflective tape or other materials adhered to the helmet in the front, sides and rear thereof. Alternatively, or in addition thereto, said person riding shall wear clothing which has reflective tape or other materials adhered thereto in the front, sides and rear thereof so it is visible from all distances within fifty(50) feet to the rear when directly in front of lawful upon beams of head lamps on a motor vehicle.

CITY OF VINELAND

Section 239-6 shall be added as follows:

Section 239-6 Lights and Reflectors on Bicycles

All bicycles when operated after sundown and/or while raining, shall be equipped with a lamp on the front which shall emit a white light visible from a distance of at least five hundred (500) feet to the rear. In addition to the lamp, a red reflector may be mounted on the rear of a type approved by the State of New Jersey which shall be visible from all distances from fifty (50) feet to three hundred (300) feet to the rear when directly in front of lawful upper beams of head lamps of a motor vehicle. All other reflective equipment shall adhere to the requirements of the New Jersey Bicycling Manual.

Section 239-7 shall be added as follows:

Section 239-7 Violations and penalties.

Any person, firm or corporation violating the bicycle helmet requirements in Section 239-4 herein, shall be subject to fines and penalties as provided in N.J.S.A. 39:10.2. Any violations of other portions of this Chapter, upon conviction thereof, shall be punishable as provided in Chapter 1. General Provisions, Article II, General Penalty.

Passed first reading:

Passed final reading:

President of Council

Approved by the Mayor:

Mayor

ATTEST:

City Clerk

New Jersey **Bicycling** Manual

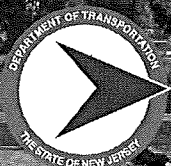
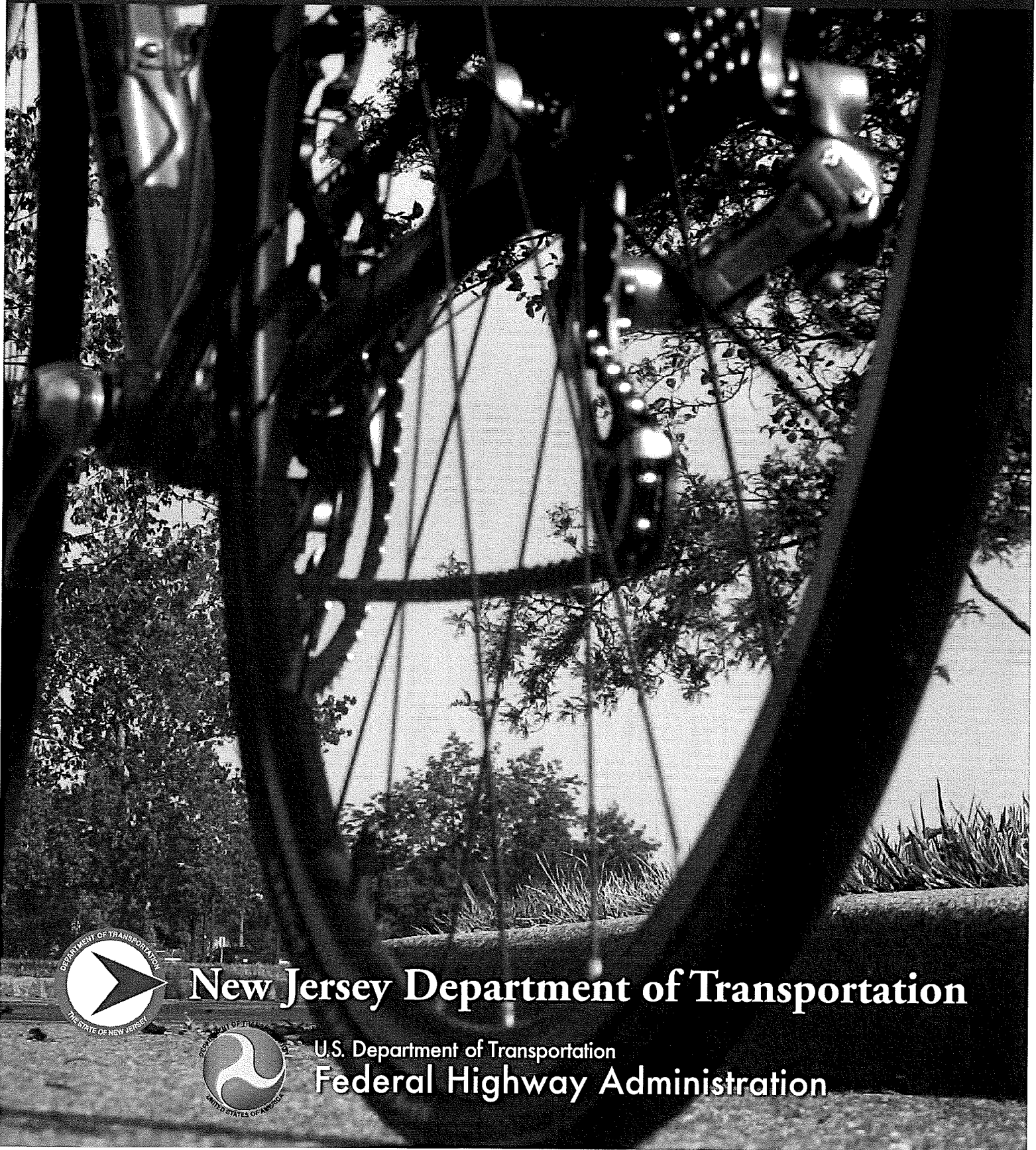

New Jersey Department of Transportation



U.S. Department of Transportation
Federal Highway Administration

New Jersey Bicycling Manual



Acknowledgements

This publication was developed under the auspices and with the assistance of members of the Safety Education Committee of the New Jersey Bicycle Pedestrian Advisory Committee.

Rich Conroy, Chairman
Carolyn Hohne
Peter Bilton
Sean Meehan
Leigh Ann Von Hagen
Elise Bremer-Nei
Debbie Kingsland
Mike Dannemiller
Bill Feldman

Bike New York
Hohne Consulting
Alan M. Voorhees Transportation Center
Alan M. Voorhees Transportation Center
Alan M. Voorhees Transportation Center
New Jersey Department of Transportation
New Jersey Department of Transportation
The RBA Group
The RBA Group

New Jersey Bicycling Manual



Table of Contents

| | |
|--|-----------|
| Traveling by Bicycle / Purpose of This Manual | 1 |
| Selecting, Fitting & Equipping Your Bike | 2 |
| Quick Maintenance Checks | 7 |
| Off to a Good Start | 9 |
| Traffic Basics | 11 |
| Sharing the Road | 21 |
| Parking Your Bike | 26 |
| Difficult Situations | 28 |
| Riding at Night & in Rain and Snow | 35 |
| Riding with Others | 38 |
| Riding on Shared-Use Paths | 39 |
| NJ Bicycling Law & Roadway Restrictions | 41 |
| Traffic Signals, Signs and Road Markings | 47 |

New Jersey Bicycling Manual



Traveling By Bicycle

Bicycling is a popular and enjoyable means of personal transportation for all ages. Increased bicycle use would yield the following benefits:

- *Can be part of an active, healthy lifestyle*
- *Promotes fitness and a sense of well being*
- *Requires no non-renewable energy sources*
- *Is inexpensive*
- *Supports smart growth initiatives*
- *Doesn't degrade the environment*
- *Is fun!*

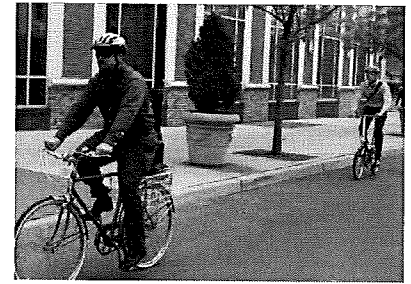

Commuting

The New Jersey Department of Transportation supports the use of the bicycle as a means of personal transportation and recreation.

Carrying out this policy involves:

- *Actively promoting the use of bicycles*
- *Implementing programs that foster and improve conditions for bicycling*
- *Designing and maintaining public rights-of-way so they accommodate bicycle traffic*
- *Encouraging and supporting other state, regional, county and local governmental agencies to adopt policies and implement programs and projects that will enhance the bicycling environment*
- *Administering grant programs that provide funding for the development of bicycle facilities and programs*
- *Providing information to the public on bicycling opportunities and safe bicycling practices*

Purpose of This Manual

The vast majority of bicycling, whether for recreation or personal transportation, takes place on our roadways. The purpose of this manual is to provide information required by bicyclists to ride on roadways with other traffic. It is intended for those who have a basic understanding of how traffic operates on our roadways, the ability to understand traffic control devices and the ability to control their bikes. Understanding the information contained in the manual and practicing bike riding skills will enable you to ride with competence and confidence.



Touring

New Jersey Bicycling Manual



Selecting, Fitting & Equipping Your Bike

Selecting the right bicycle, making sure it fits, and having the right equipment are the key considerations for making sure your bike suits your needs.

Choosing a Bicycle

There are many types of bicycles. Your choice depends on what you intend to use it for and your style of riding. Lightweight **Road Bikes** are great for racing and recreational touring. **Recumbent Bicycles** offer an alternative seating position. **Mountain Bikes, City Bikes and Hybrids**, including a number of bikes that have been developed mainly for utilitarian trips, are suited to city riding and commuting because of their upright sitting position, accessible gear shifters and brakes, rugged construction and maneuverability. They are slower and less efficient for longer distance riding and touring than road bikes. They may also be better for trail riding. **Cruiser Bikes** with fixed or internal hub gears are fine for neighborhood or boardwalk riding.

Getting a Good Fit

Having a correctly sized and properly fitted bicycle is necessary for your comfort and will better enable you to control your bike. Some parts of the bike can be adjusted to fit; however the frame cannot, so it is especially important to get the correct frame size. The staff at the store where you purchase your bike should help you choose the correct frame size and properly adjust the seat and other components.

Frame Size - In general, you should be able to straddle the top (horizontal) tube of the bike while standing flat-footed, with an inch or so clearance for road bikes, 3-4 inches for mountain bikes and 2-3 inches for hybrids.

Seat Height - The seat height should be adjusted so your knee is slightly bent when your foot is at the bottom of the pedal stroke with the ball of your foot centered over the pedal. The "minimum insertion" line on the seat post should be below the top of the seat tube.

Handlebars - Adjust the handlebars so you feel comfortable. Make sure the stem is positioned no higher than the "maximum extension" mark. The bars can be rotated to achieve a more comfortable position. If you feel like you are reaching too far for comfort while in riding position, you may be able to substitute a stem with a shorter neck or you may be able to move the saddle forward a bit. If this doesn't work, you may need a smaller frame size or one with different geometry.



Road Bike



Mountain Bike



Recumbent

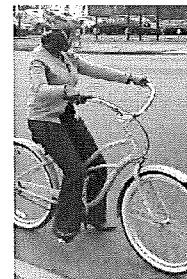

Cruiser



Astride the Top Tube

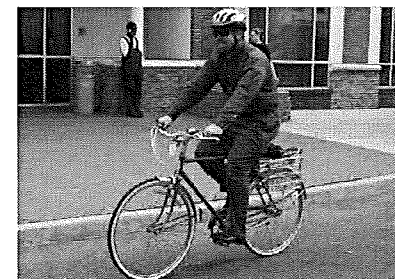

Bicyclist Sitting Correctly

New Jersey Bicycling Manual



Basic Equipment /Choices

Some equipment is required. Other equipment is available to make bicycling more functional or enjoyable.

Helmet - In the event of a crash, a properly fitted helmet can prevent or reduce the severity of head injuries. In New Jersey anyone under 17 years of age must wear an approved helmet. Your helmet should meet the safety standards of the Consumer Product Safety Committee or the Snell Memorial Foundation (N.J.S.A. 39:4-10.1).



The Correct Fit

Gears - Most adult bicycles have a system of gears that enables bicyclists to ride efficiently in varying condition of terrain, wind and pavement smoothness. Learning to use the gears effectively will dramatically improve your bicycling experience. This requires practice.

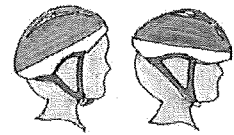

Wrong Fit

The most common system of gears involves the use of one or more chain rings attached to the pedal cranks and a series of cogs attached to the rear axle. The different gear selections involve wrapping the chain around one of the chain rings and one of the cogs. Derailleurs move the chain from one chain ring to another or one cog to another. The derailleurs are operated by cables triggered by shifters that are usually located on the handlebars. Moving the chain to the left puts you in easier, lower gears for climbing. Moving the chain to the right puts you in higher, harder gears for going fast. Middle gears are used for conditions in between.

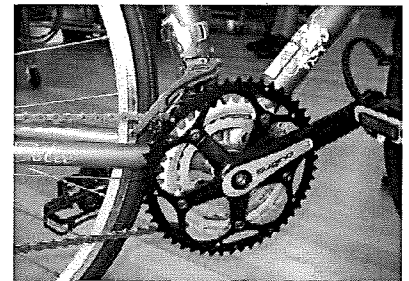

Derailleur Bike Chain Rings

Another type of gearing is referred to as internal hub gearing. The gears are located inside the rear hub. With internal hub gearing, three to eight gears are usually available. Internal hub gears are simple to operate. They are protected from the elements and require little maintenance.

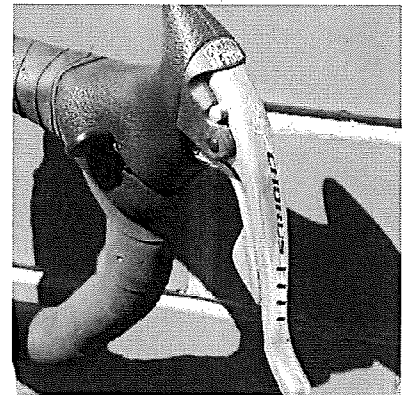

Brakes on Handle Bar

The type of gearing system and the number of gears depends on the type of riding you will do. If you are unsure of the type of gearing to choose, ask staff at a bike shop.

Brakes - Should be easy to reach, comfortable to grasp and powerful enough to quickly bring your bike to a stop. In New Jersey, the brakes must be powerful enough to make the wheels skid while stopping on dry, level, clean pavement (N.J.S.A. 39:4-11.1).

Bell or Horn - A bell or other warning device is a legal requirement in New Jersey. It will probably not be heard by motor vehicle drivers, but it is useful as a warning and as a courtesy to alert other bicyclists and pedestrians of your approach (N.J.S.A. 39:4-11).

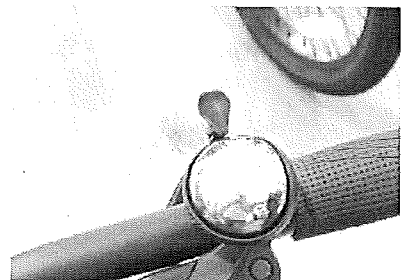

Bell on Handle Bar

New Jersey Bicycling Manual



Lights/Reflectors - Cyclists are practically invisible to motorists at night when they don't use lights and reflective gear. If you ride at night, do everything you can to make yourself visible.



Front Bicycle Light



Rear Bicycle Light & Reflector

When in use at nighttime every bicycle must be equipped with: 1) A front headlamp emitting a white light visible from a distance of at least 500 feet to the front; 2) A rear lamp emitting a red light visible from a distance of at least 500 feet to the rear (N.J.S.A. 39:4-10). Reflective material can further increase your visibility and can be used on your helmet, shoes and clothing.

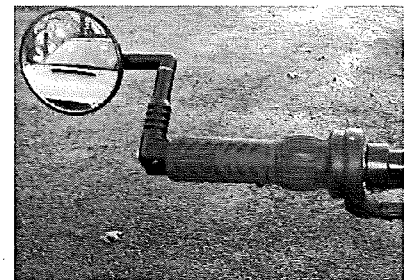

Handle Bar Mounted Rear-View Mirror

Rear-View Mirror - A mirror is a valuable safety device. It allows you to observe behind you without turning around, which helps you to maintain control of your bike. They are available in models that attach to your helmet, glasses or handlebar.

Bicycling Gloves - Padded cycling gloves provide cushioning, prevent numbness and protect your hands from scrapes in a crash.

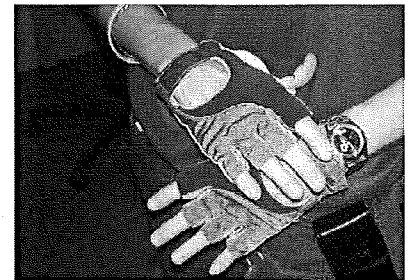

Padded Bicycling Gloves

New Jersey Bicycling Manual



Toeclips/Clipless Pedals - Toe clips (cages with tightening straps that allow the rider to secure their foot to the pedals) and clipless pedals (which allow cleats on cycling shoes to snap onto the pedal) increase cycling efficiency. These devices do take time to learn to use.



Toe Clip

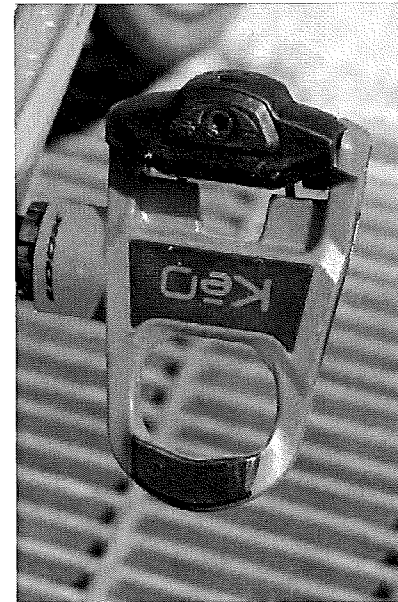

Clipless Pedal

Bike Rack/Bike Bag/Panniers - A luggage rack and bike bag or panniers enable you to safely and easily carry food, clothing, a repair kit and shopping purchases. Items can be secured to the bike rack with bungee cords. Do not hang objects from your handlebars and do not try to carry objects in your hands.



Bike Bag



Panniers

Fenders - Fenders keep you dry and clean. They also prevent lights and reflectors from getting dirty and obscured in wet weather.

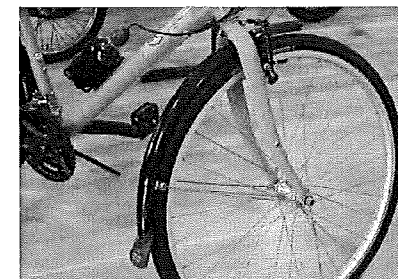

Bike Fender

New Jersey Bicycling Manual



Water Bottle and Bottle Cage - For all but the shortest trips, drinking water en route will be necessary to keep you from getting dehydrated. Also, pouring water over a flat but partially-inflated inner tube can reveal the location of a puncture.

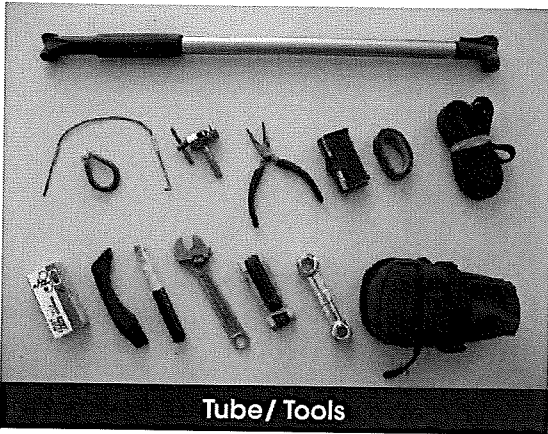

Tube/ Tools

Tools and Pump - When riding more than an easy walking distance from home, and especially for long distance touring, having the tools and spares needed to fix flats and make minor repairs, and knowing how to use them is essential. This includes a patch kit and spare tube, a pump or

other device for inflating the tire, tire "irons" and a small assortment of tools or a "multi-tool" that fit the nuts, bolts and screws on your bike.

Lock - To prevent your bike from being stolen, always lock it when you park it. There are a variety of locking systems. A cable (or chain) and padlock are most common but generally not as secure as a "U-lock". Selecting a lock involves trade-offs. No locking system is theft proof, and unfortunately the heavier duty the lock, the heavier and more cumbersome it tends to be. When you park your bike, make sure you lock the frame and both wheels to a bike rack or other fixed object (not a tree). Take items with you that can be easily stolen (e.g., helmet, tools, etc.).

Identification/Medical Information/Cell Phone - Carry identification, emergency medical information and emergency contact information on your person (not in the bike bag). Wristband and shoe tag ID's are available. A sticker placed inside your helmet is another option. A cell phone provides a sense of security and a means of communication, especially in an emergency situation.

Glasses - Good quality, non-shattering wrap-around sun glasses protect your eyes from wind, dirt, debris, insects, and the sun while riding.

Pants Clips/Ankle Straps - If you are wearing trousers, use a Velcro strap with reflectorized material or metal clip to secure your pants close to your leg. A rubber band works, too. This will keep your pants from rubbing against the chain and getting greasy, or worse, getting them caught between the chain and chain rings.

Other - Other equipment that might come in handy includes a flashlight with spare battery and a small rag for handling greasy or gritty parts.

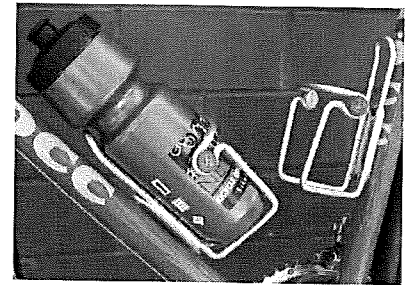

Bottle Cage & Water Bottle



Frame Pump

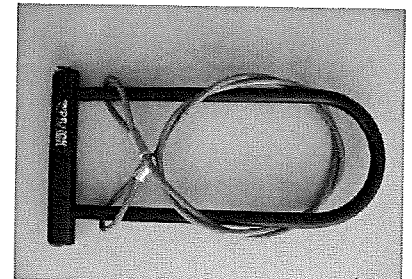

U-Lock & Cable

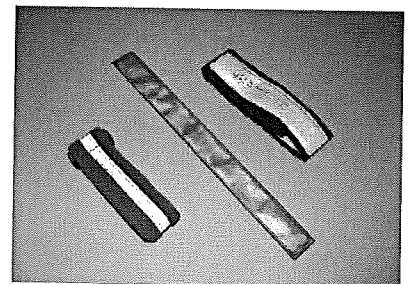

Ankle Straps

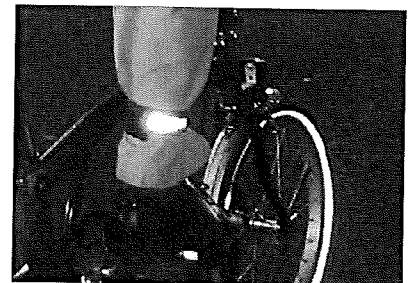

Reflective Strap

New Jersey Bicycling Manual



Quick Maintenance Checks

Major maintenance can be left to the professionals, but there are things you should always check before you get on your bike and ride off.

Air Pressure - Check your tire pressure, preferably with a pressure gauge for accuracy. If your tire is not up to the recommended pressure (imprinted on the side wall of the tire), add air. If you don't have a gauge, squeeze the tire hard or push it against a hard surface or curb. If you can significantly deform it, add air.

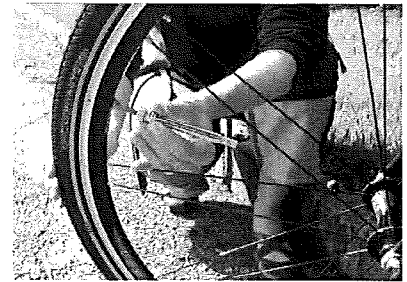

Checking Tire Pressure

Tires - While rotating each wheel slowly, look for cuts or bulges. If you see any, replace the tire. If the valve stem is crooked, let out the air and reposition the valve stem so it is straight (you may have to remove the tire to do this). Remove any debris or glass stuck to the tire by spinning the wheel while holding a cloth against it.



Checking Tire for Damage

Wheels - Slowly spin each wheel to make sure it doesn't wobble or rub against the frame or brake pads. If it does, a simple readjustment may solve the problem. If not, you may need to have your wheel trued. (This should be done by an experienced mechanic).

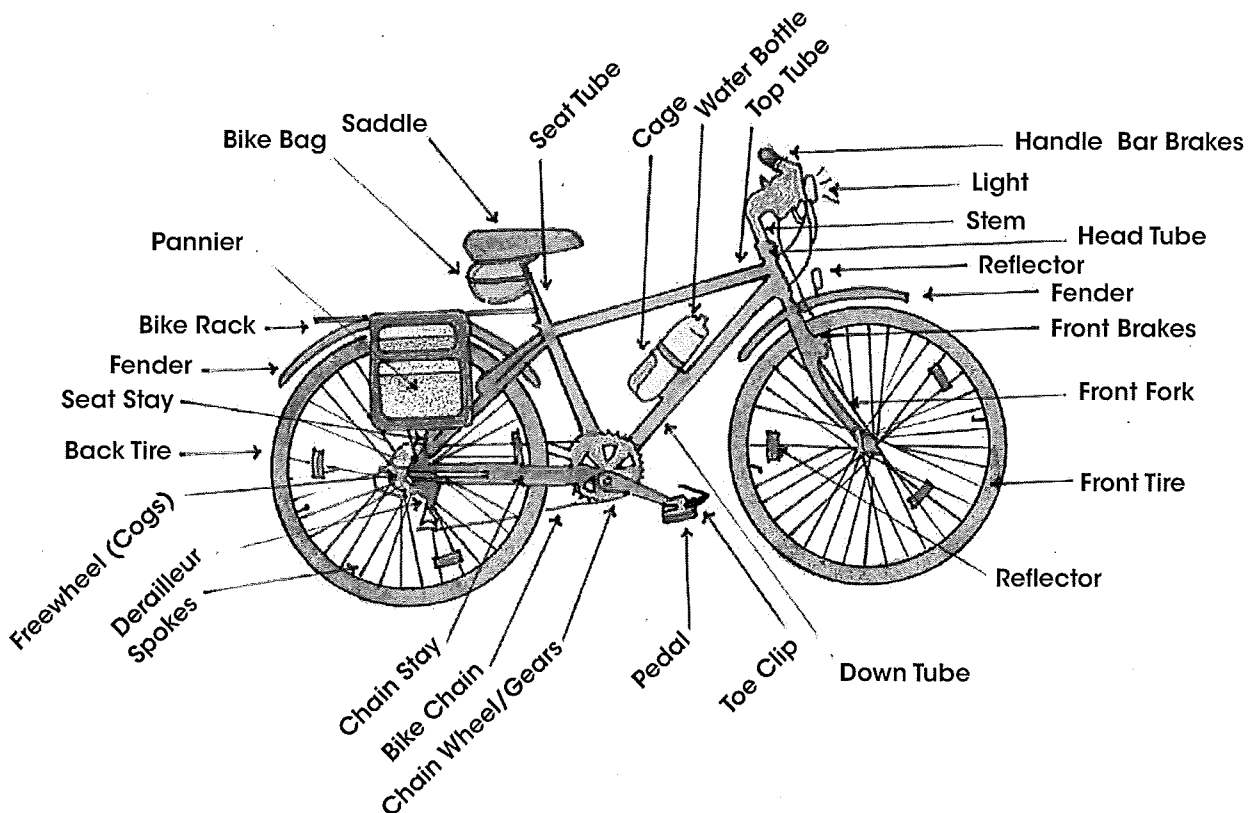

New Jersey Bicycling Manual



Brake - Lift each wheel, spin it and apply the brakes. If you can squeeze the brake handle all the way to the handlebar or if the brake pads don't evenly and firmly contact the rim (and only the rim - not the tire) your brakes need to be adjusted. Similarly, if you engage the brake and push the bike hard against and along the pavement, and you can't make the tires skid, the brakes need to be adjusted.

Chain - Check the chain. If it is dry or links are "frozen," spray the chain using a spray lubricant while rotating the pedal backwards. Then wipe off the excess lubricant by grabbing the bottom of the chain with a rag and rotating the pedal backwards. You can remove grit and grime from your chain the same way.

Gears - After mounting the bike and starting to ride, but before you ride off, shift through all gears. If the chain rubs against the derailleur cage, won't shift into all gears or jumps gears, or if the shifter sticks, then your derailleur or cable needs to be adjusted and/or lubed.

Seat and Handlebars - While holding your front wheel firmly, try to rotate the handlebars side to side, and while holding the frame firmly try to rotate the saddle. If they move, they need to be tightened.

Nuts and Bolts - Grasp the neck of the handlebar stem, lift the front of the bike off the ground a couple of inches and let it drop to the pavement. If you hear something rattle, tighten it.



Checking for Loose Parts

New Jersey Bicycling Manual



Off to a Good Start

Get Into Shape

All things being equal, the more physically fit you are, the easier and more enjoyable your bicycling experience will be. The beauty of cycling is that you can bicycle to achieve health, vitality and fitness. As with any physical activity, start with short slow-paced rides, preferably in settings where other traffic is minimal and slow moving. Gradually work up to longer rides. This approach will enable you to improve your fitness and bike handling skills.

Dress Properly

Proper dress for cycling is a function of the purpose of your ride, the weather, and how you want to look when you get to your destination. There is plenty of specialized clothing made for cycling in just about any weather: jerseys, shorts, tights, ponchos, jackets, shoes. For many trips regular street clothes are fine. Always wear a helmet!

Plan Your Route

Do some exploring to find the best route. You may discover that the best route is not necessarily the one with the least traffic.

Other considerations are:

- Directness,
- Smoothness of pavement,
- Hazards such as blind intersections, stream flow type sewer grates, railroad tracks,
- Number of signals or stop signs,
- Terrain,
- Traffic speeds,
- The amount of truck or bus traffic,
- The existence of paved shoulders,
- The availability of designated facilities such as bike lanes, signed routes or shared-use paths,
- The width of outside lanes.

If the outside lane is wide enough to accommodate both a car and a bicycle, that road may be a better choice for bicycling than a narrow street with less traffic. If available, use county and local maps to help plan your route. They show local roads and streets. Some counties and municipalities publish bicycle maps. The NJDOT publishes a series of tour guides for cyclists and provides references to other information to help plan your route (www.njcommuter.com).

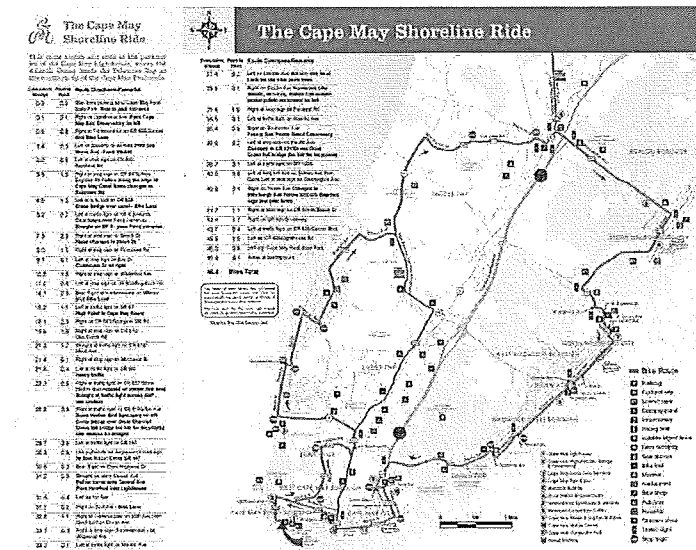
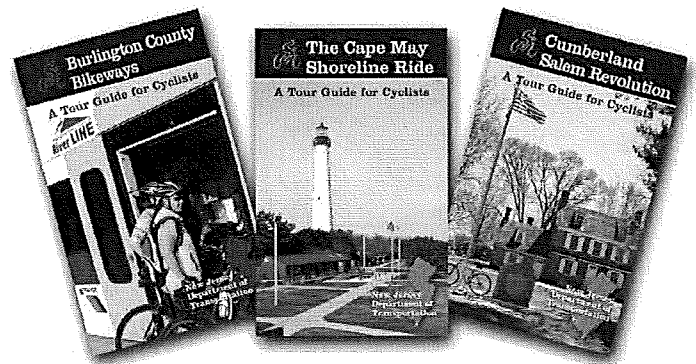

NJDOT Provides Many Bicycle Tour Guides & Maps

New Jersey Bicycling Manual



Give Yourself Enough Time

For example, plan at least one-half hour for a four mile trip. Take your time and enjoy the ride. That way you'll arrive at your destination fresh, not hot and sweaty; invigorated, not exhausted. A washcloth and hand towel should be all most people need to freshen up. If showers and lockers are available, so much the better.



Traffic Basics

Be Responsible

Driving a bicycle requires you to be responsible for your actions, for your safety and for the safety of others. This involves learning what is required to properly handle your bicycle and practice your bicycle driving skills so you can maintain control and execute whatever maneuvers are required in a given situation. Know, understand and comply with the law as it pertains to equipping and operating your bike. This manual provides the information required to enable you to fulfill your responsibilities.

Be Visible and Predictable

A person riding a bicycle is less noticeable or conspicuous than a motor vehicle (both in terms of being seen and heard). It is important that you take steps to enhance your visibility. Wear light, bright colored and/or reflective material. Use front and rear lights and use caution when riding at night.

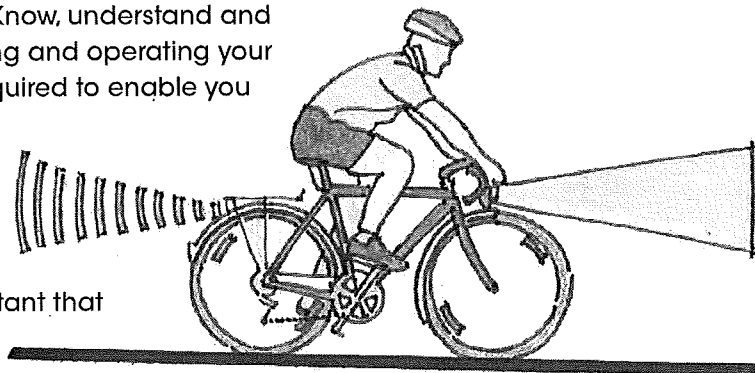

Be Visible

Motorists may not be aware of a bicyclist's rights to ride in the roadway, or may not be looking for bicycle traffic. Therefore, when riding in a public right-of-way, in order to be seen, you need to operate in a way that increases the chances that other traffic will notice you. The best way to do this is to ride in accordance with the rules of the road, which you are required to do by law. This insures that you will be positioned where motorists are trained to look for other traffic. In addition, it is not enough to be observed. You need to be predictable. The best way to do this is by riding with competence and confidence. This will give motorists the idea that you know what you are doing so that they can anticipate your actions.

Ride Right

This means riding on the right side of the road or on the shoulder, with traffic, not against it. The law says you must ride as far to the right as practicable. This does not mean as far to the right as possible. Don't "hug the curb" where you may not be visible to motorists. You should ride far enough out from the edge of the pavement to avoid broken up pavement edges, debris, drainage grates and standing water. Travel in a straight line; not weaving in and out of parked cars. Stay about four feet away from parked cars to avoid the possibility of having a door opened in your travel path (getting "doored"). Riding right also means obeying traffic signals and signs, taking and yielding right-of way appropriately and riding in a straight line.

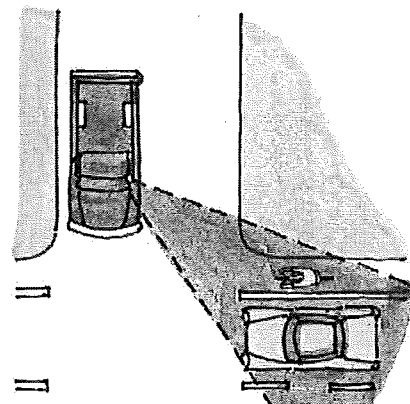

Ride With Traffic to be Seen

New Jersey Bicycling Manual

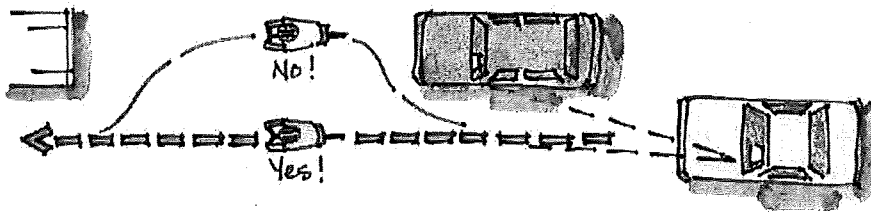

Don't Weave Between Parked Cars

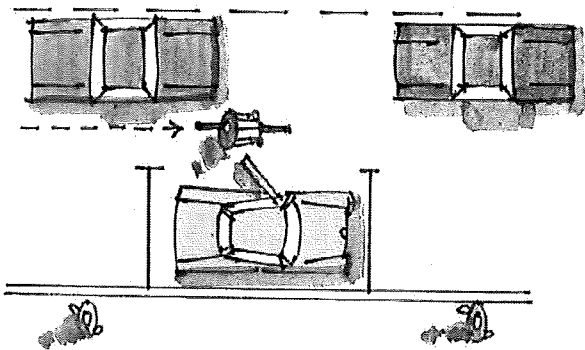

Always Ride 4 Feet from Parked Cars to Avoid Open Doors

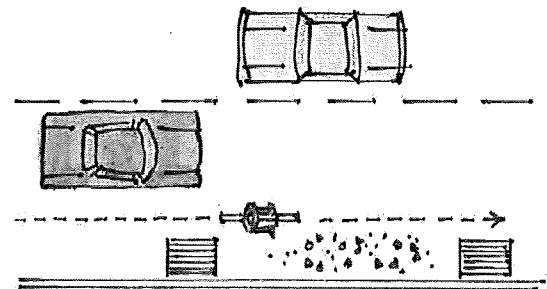

Avoid Road Hazards

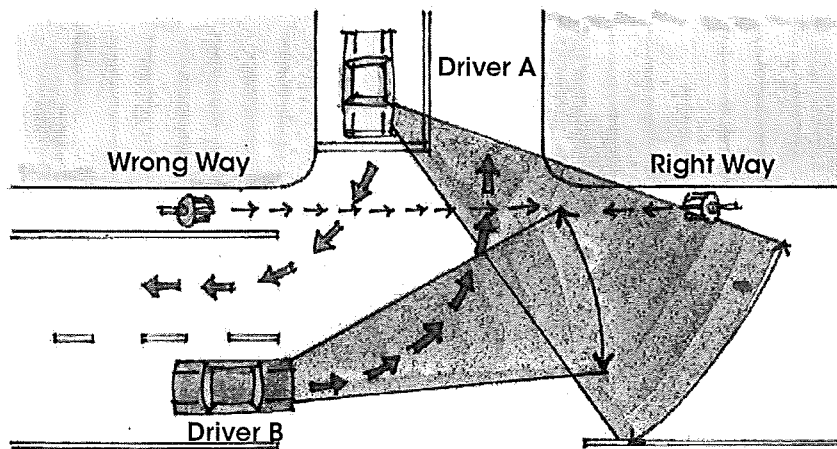

Wrong Way Rider

When You Can Move Left

Under New Jersey law, a bicyclist may move left under any of the following conditions: 1) To pass a standing vehicle; 2) To make a left turn from a left turn lane or pocket; 3) To avoid debris, drains, or other hazardous conditions on the right; 4) To pass a slower moving vehicle; 5) To occupy any available lane when traveling at the same speed as other traffic; 6) To travel two abreast when traffic is not impeded, but otherwise ride in single file (N.J.S.A. 39:4).

New Jersey Bicycling Manual



Be Attentive/Maintain Control

Most collisions are caused by driver error. Drivers (bicycle or motor vehicle) can reduce the chances of a collision by knowing and using the standard collision-prevention formula:

- **Be Alert:** *Never think the other drivers will not make a mistake.*
- **Be Prepared:** *Learn what to do in any situation when you need to act fast, and always expect the unexpected.*
- **Act in Time:** *Plan ahead, anticipate turns stops and lane changes; don't try maneuvers at the last second.*

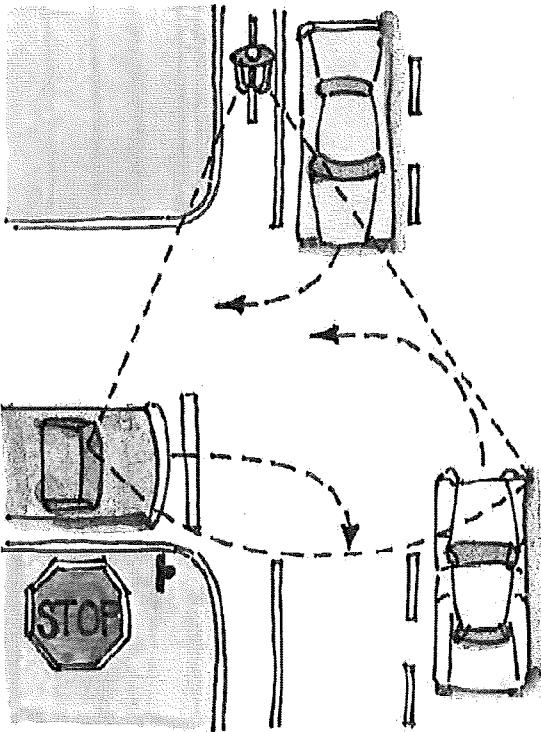

Scan the Road Around You

Scan the roadway ahead for potential road hazards. Be alert to the movement of other traffic around you, especially as you approach intersections. Check behind you periodically using your rear-view mirror for overtaking traffic. Keep at least one hand on the handlebars at all times. Scan parked cars ahead and be alert to the possibility that a motorist might open their car door. Watch for cars pulling out of driveways or side streets for pedestrians at or approaching the curb. Be ready to brake or to take other evasive maneuvers. Don't ride your bike under the influence of alcohol or drugs. Don't wear headphones or try to talk on a cell phone or text message while riding.

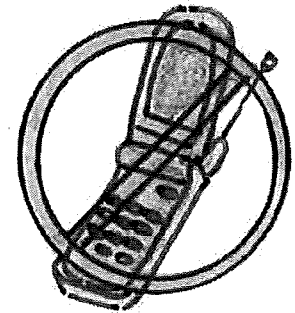

**NO Cell Phones
or Head Phones**

Signal and Communicate

Use hand signals to make sure that you let other road users know in advance that you are going to change lanes, turn, and, since your bike doesn't have brake lights, that you are slowing down or stopping. Don't assume that nearby motorists see you. Try to establish eye contact with other drivers. If they are clearly not looking at you, you must assume that they don't see you and stay out of their way. Even if you think they are looking in your direction, they may not actually see you, so you need to be prepared to slow down, stop, or take evasive action.

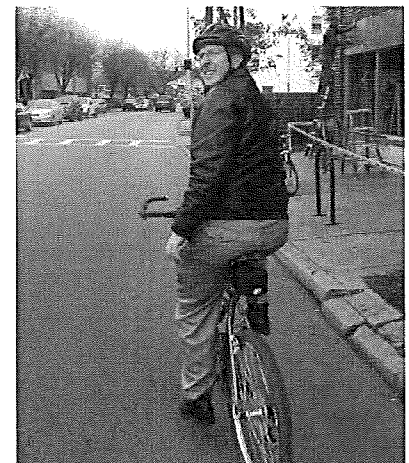

Rider Looking Behind

New Jersey Bicycling Manual

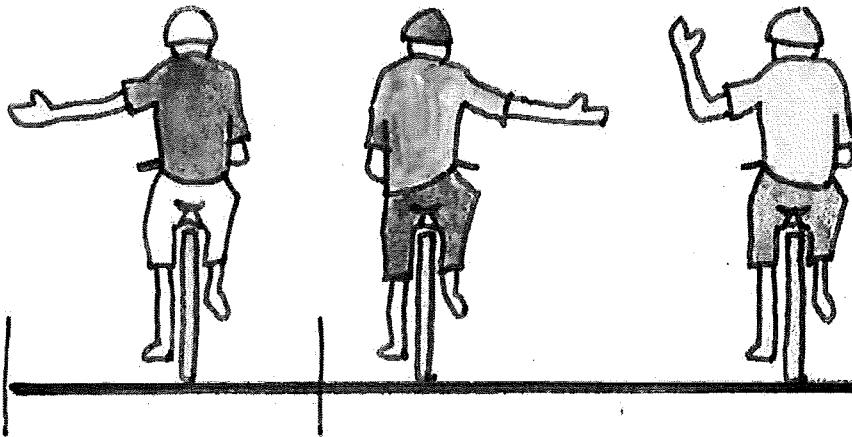

"Left Turn"

"Right Turn" Options

Yielding the Right-of-Way

Since bicyclists have the same rights and responsibilities as drivers of motor vehicles, the rules that govern the right-of-way for motorists apply to drivers of bicycles. A bicyclist should always be prepared to yield and are required to yield to:

- *Emergency vehicles: when police cars, fire engines and ambulances are giving warning signs (sirens, flashing lights)*
- *Buses: when re-entering the flow of traffic*
- *School buses: when stopped with red lights flashing*
- *Postal vehicles: when vehicle is seeking to re-enter the flow of traffic*
- *Pedestrians: when in a crosswalk or seeking to cross a road*
- *Motorized or mobility-assistance devices: when in a crosswalk or seeking to cross a road*
- *Other vehicles that are already in the intersection*
- *If you and another vehicle approach an uncontrolled intersection at the same time, the driver on the left yields to the driver on the right; turning traffic yields to through traffic*
- *If you are changing lanes, you must yield to traffic in the lane you are entering*



Rider Signaling
Slow/Stop



Don't Ride on Sidewalks

Sidewalks are for pedestrians. Although riding a bicycle on a sidewalk is not prohibited by statute, some municipalities have passed ordinances prohibiting bicycle traffic on certain sidewalks. This prohibition is usually posted. Riding on sidewalks can cause conflicts with pedestrians and, because it places bicyclists in situations where motorists do not expect them, it can lead to crashes. Except for very young cyclists under parental supervision (and not crossing intersections) sidewalks are not for bicycling.

Be Part of the Traffic Mix

New Jersey traffic law accords bicyclists the same rights and responsibilities as drivers of motor vehicles. In general, you are best served if you operate your bicycle as you would a vehicle, following the rules of the road and obeying all traffic signals, signs and pavement markings.

Single File

New Jersey Law allows bicyclists to travel up to two abreast (but not more than two) when traffic is not impeded. Given the relatively high average traffic volumes on New Jersey roadways, there is limited opportunity to ride side by side with another bicyclist. (An exception would be where there are wide shoulders.) If you are riding two abreast, as soon as you begin to impede the flow of traffic, you must resume riding single file as described above. As a general rule, it is best to ride single file.

Extra-Wide Lanes

Lanes (14 feet wide or more, exclusive of parked cars) provide enough space for lane sharing (cars and bikes can ordinarily travel side by side and cars can pass without having to move moving over into the next lane). The basic lane position would be approximately four feet from the edge of the pavement.

"Normal" Width Travel Lanes

In lanes 13 feet wide or less, most vehicles, especially wide ones, will have to move left to comfortably pass. In these situations, if a bicyclist rides too close to the edge of the lane, they may "invite" motor vehicles to pass without moving left, and in so doing the bicyclist may end up being squeezed off the road, into parked cars or drainage grates or other roadside or road edge hazards. Therefore, the best approach is to position yourself several feet out into the lane where motorists will see you and not be invited to squeeze by in the same lane.

Select Proper Lane Position for the Situation.

Between intersections, keep as far right as practical. Don't "hug the curb" where debris collects or where you won't be visible to motorists. Move left to pass slow traffic or obstacles (but check for overtaking traffic). If the outside lane plus shoulder (if available) is too narrow for side-by-side sharing with motor vehicles, move toward the middle of the lane (i.e., "take the lane") to indicate that motorized traffic must change lanes to pass safely.

When approaching and at intersections, determine your lane and position within the lane by the direction you want to go. Position yourself so your intentions are clear. If there is only one lane for travel in your direction, approach the intersection in the part of that lane that corresponds to the direction you are going. When you have a choice of lanes to use, ride in the right-most lane that goes in the direction you want to go.

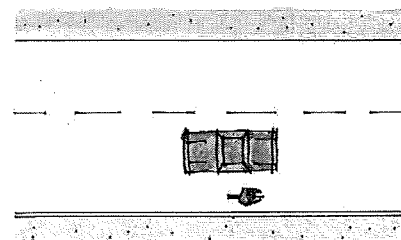

Rider Side-By-Side with Car in Wide Lane

New Jersey Bicycling Manual



Riding in a Narrow Lane

On narrower lanes (or lanes narrowed by parked cars) ten feet or less, a bicyclist may want to "take the lane", by positioning themselves at or near the center of the lane. This enables them to be seen by overtaking vehicles and gives the message that the overtaking vehicle must move left to pass...when it is safe to do so.

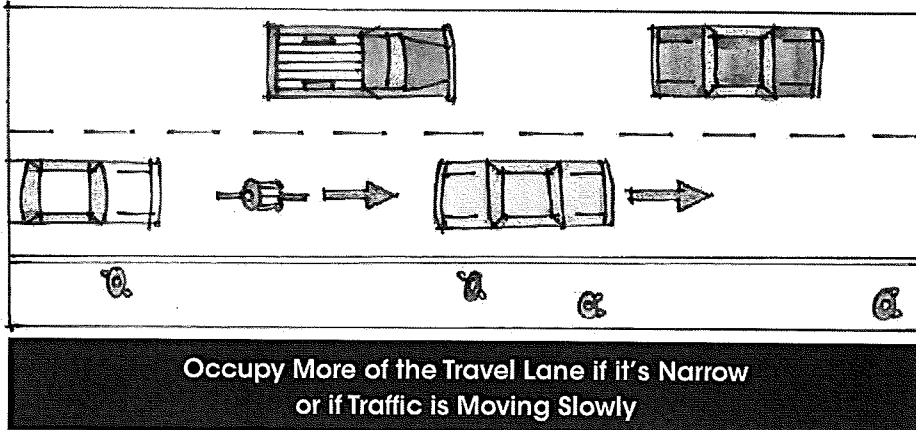

Passing

A bicyclist may move left in order to pass slower moving traffic. If you encounter a slower moving motor vehicle you should look behind you to ascertain traffic conditions. When there are no overtaking vehicles and there is an adequate gap in traffic, signal left, then move left into the left lane and pass.

If there is only one travel lane in your direction and the lane is wide enough to accommodate side by side sharing of the lane by motor vehicle and bicycle traffic, then you can execute a passing maneuver by riding near the lane line. If the lane is not wide enough for side by side sharing and there is a double yellow centerline, slow down and follow the slower vehicle until conditions change and you are able to pass.

If you begin to pass, and the motorist speeds up, look behind to gauge traffic conditions, and when conditions permit, signal right, and move in behind the vehicle you had intended to pass.

Drivers generally don't expect traffic to pass on the right, so...**don't pass on the right**. Cyclists who do so are vulnerable to being squeezed into the curb or parked cars, or of being cut off at an intersection if the vehicle you are attempting to pass makes a right turn.

Passing Another Bicyclist - Again, don't pass on the right. As you approach a slower bicycle, call out your intention to pass by shouting "on your left". Then, after determining that you are clear of other traffic, signal your intention to move left, and pass, allowing at least three feet of clearance.

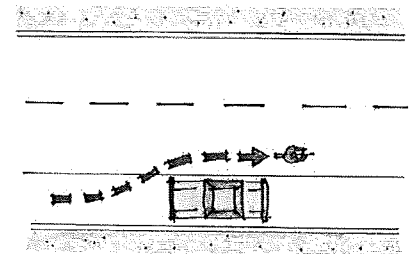

Rider Moving Left to Pass Standing Car

New Jersey Bicycling Manual



Passing Buses - As with other motor vehicles, pass a bus, whether it is moving or stopped, on the left. Be especially careful as you approach the front of the bus. Look for discharging passengers walking out from in front of the bus. Also, be alert to the possibility of the bus moving ahead. Don't pass a bus stopped at a corner to make a right turn in front of it. It could begin to move away from the curb and merge into traffic at any time.

Intersections and Turns

You must be especially vigilant when negotiating intersections, since this is predominantly where you encounter other traffic. As you approach the intersection, observe and obey any traffic control devices, including law enforcement officers directing traffic. At uncontrolled intersections yield to other traffic when you are required to do so. Select your lane and your position within it based on the direction you want to travel. Position yourself so your intentions are clear. If there is only one lane for travel in your direction, approach the intersection in the part of that lane that corresponds to the direction you are going. When you have a choice of lanes to use, ride in the right-most lane that goes in the direction you want to go. Before proceeding into the intersection, you need to check behind you to observe the movements, including speed and signals of overtaking traffic (including bicycle traffic).

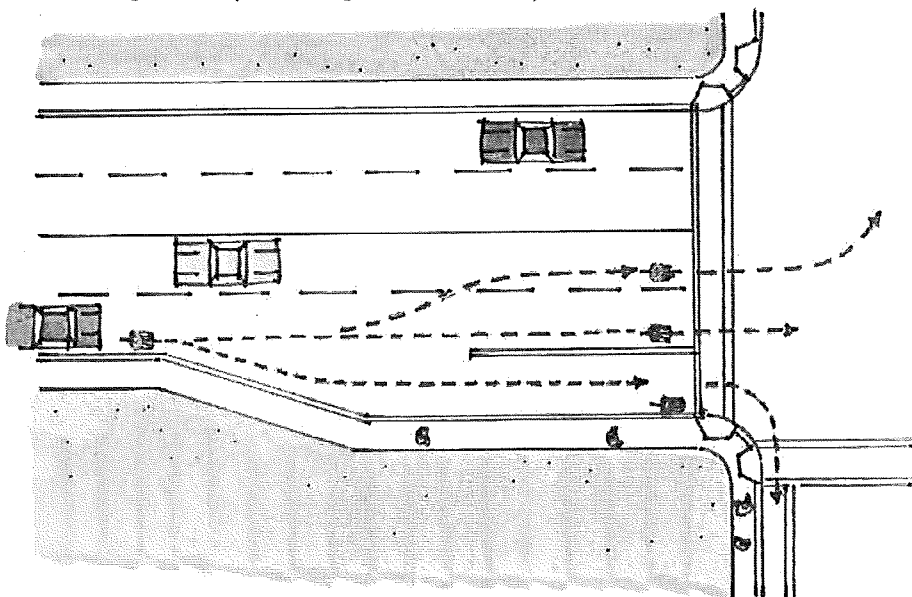

Choose the Correct Lane

Going Straight Ahead - When travelling straight ahead, stay in your basic mid-block lane position as you approach the intersection. Don't swerve right or left. As you enter the intersection, choose a travel path directly to the place where you will be riding on the other side of the intersection. Don't swerve right or left.

New Jersey Bicycling Manual



Right Turns - Select the right-most lane from which you can make a right turn. As you approach the intersection, signal your intention to turn. Stay in the basic lane position, and proceed around the corner. Don't move to the right in the lane as this may result in your being squeezed toward the curve as you make the turn.

Left Turns - Making a left turn requires more advance preparation than right turns and passing straight through an intersection. Well before you reach the intersection where you intend to turn, you need to begin to scan behind you to ascertain traffic conditions. If there is overtaking traffic, you need to begin to look for an acceptable gap in traffic, one with enough space to allow you to move over towards the center line.

Turning Left from One Travel Lane - If there is only one lane in your direction of travel, scan until you identify an acceptable gap, signal your intention, move to the left and take a position about four feet from the centerline. From this position, motor vehicles won't be able to pass you on the left and cut you off. If there is a car stopped at the intersection, pull up behind the vehicle and stop. If cars pull up behind you, this is a good time to make a left turn signal and look behind to make sure the driver behind you understands your intentions. Once you have the right-of-way (signal is green or you have stopped for a stop sign and determined that intersecting traffic in both directions has cleared the intersection,) you can begin to move out and negotiate your turn. As you do so, you need to observe oncoming traffic to make sure that there is an acceptable gap before completing your turn.

Turning Left If There Are Two or More Travel Lanes in Your Direction - If there are two or more travel lanes in your direction of travel, none of which are designated as a left turn lane, you need to repeat the process outlined above in order to move into the lane next to the centerline. Then, proceed as described above.

Turning Left If There Are Designated Left Turn Lanes - If there is one or more designated left turn lanes, follow the process described above and move into the left turn lane. If there are more than one left turn lanes, move into the right-most designated left turn lane (unless you are going to make two left turns in quick succession, in which case, move into the left-most left turn lane).

The Box Left Turn - If you want to make a left turn and you sense that conditions are too difficult for your skill level, you may make a "pedestrian" or "box" left-hand turn by riding to the far side of the intersection, dismounting, repositioning your bike behind the stop bar on the intersecting street, and proceeding when you have the right-of-way to do so. If traffic is queued up and there isn't enough pavement width to get behind the stop bar then position your bicycle in front of the queued traffic; but make sure not to block the crosswalk.

New Jersey Bicycling Manual



Turning Left at Non-Traditional Intersections - If you encounter an intersection with more than four legs, where you have the opportunity to make a slight left and a "hard" left, it is best to make a vehicular style left turn if you can. If you need to resort to a box left turn, travel to the corner of the further intersecting street, reposition yourself as described above and proceed when you have the right-of-way.

On- and Off-Ramps

If you bicycle in New Jersey, sooner or later you will encounter ramps associated with jug handles or grade separated intersections or interchanges (where one road passes over the other). Depending on the configuration, you can encounter on ramps and off ramps on either the approach side (near side) of an intersection (or interchange) or on the departure side (far side).

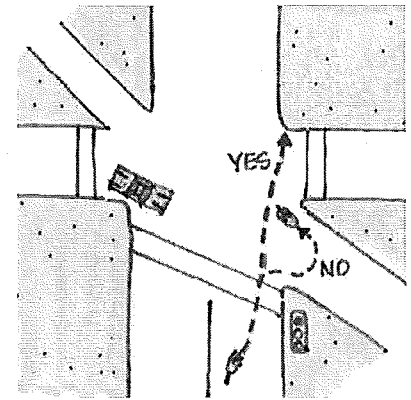

Turning Left at Complex Intersections

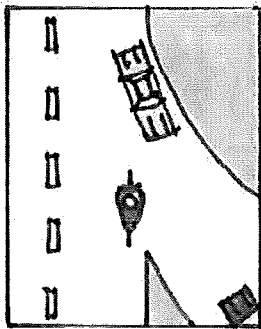

Cars Merge Ahead of Bike

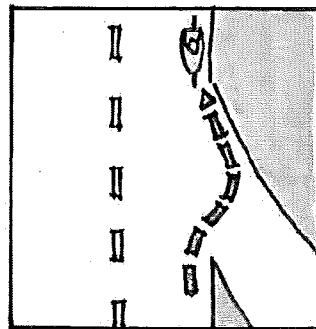

Move Right as Soon as Possible if there is a Break in Ramp Traffic

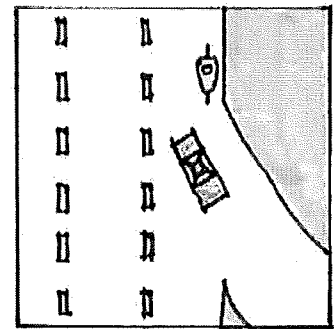

Cars Merge Behind Bike

When you encounter an on ramp, drivers entering the roadway will be speeding up on your right in the acceleration lane. Stay in your basic straight ahead lane position. At first, drivers will pass you on your right and merge into the through lane ahead of you. Hold your position. Don't swerve over to the right side of the acceleration lane. As you proceed further, traffic will merge into the through lane behind you and pass you on the left.

When you encounter an off ramp, if you are turning onto the intersecting roadway, signal your intention and merge over into the right side of the deceleration lane (if there is one) or the off ramp, and proceed to complete your turn. This may involve merging onto the intersecting roadway, or stopping at the intersecting road (if you take a near side jug handle ramp and are proceeding to turn left or right when you have the right-of-way and when there are adequate gaps in traffic on the intersecting roadway.) If you are going straight, stay in your basic straight ahead lane position. Be cautious because at first, traffic may pass you on the left and merge into the deceleration lane if there is one, then into the off-ramp. As you proceed towards the ramp itself, traffic should merge into the deceleration lane behind you.



Traffic Circles

There are no set rules for driving into, around and out of a traffic circle in New Jersey. Common sense and caution must prevail at all times. In most cases, the circle's historically established traffic flow pattern dictates who has the right-of-way. If a major highway flows into and through the circle, it usually dominates the traffic flow pattern and commands the right-of-way. Traffic control signs, such as stop or yield signs, at the entrances to the circle also govern which motorist has the right-of-way. Never enter a traffic circle without checking all signs and determining the intentions of the motorists already moving within the circle.

Whenever a bicyclist is in doubt concerning who has the right-of-way in a circle, he/she should exercise extreme caution and remember the basic rule governing any uncontrolled intersection: the vehicle to the left yields the right-of-way to the vehicle approaching from the right.

In general, a bicyclist should enter the circle in the right (outside) lane. If you are going to exit the circle at the first opportunity, regardless of the number of lanes in the traffic circle, stay in the outside lane, signal your intention to turn right, and execute a right turn at your exit in a manner similar to turning right at a regular intersection.

If you intend to go past the first exit, if the circle accommodates more than one lane of traffic, signal and negotiate a lane change to the outside portion of the interior lane. As you approach your intended exit, move to the outside lane, and execute a right turn at your exit as described above.

Roundabouts

Modern roundabouts are a particular type of traffic circle now being constructed in New Jersey. They operate on the "yield on entry" rule, i.e. traffic about to enter the roundabout must yield to the traffic in the roundabout. These facilities are signed accordingly. If you feel uncomfortable negotiating a traffic circle or roundabout, you can always dismount and walk your bicycle through the crosswalks to get around the circle or roundabout.

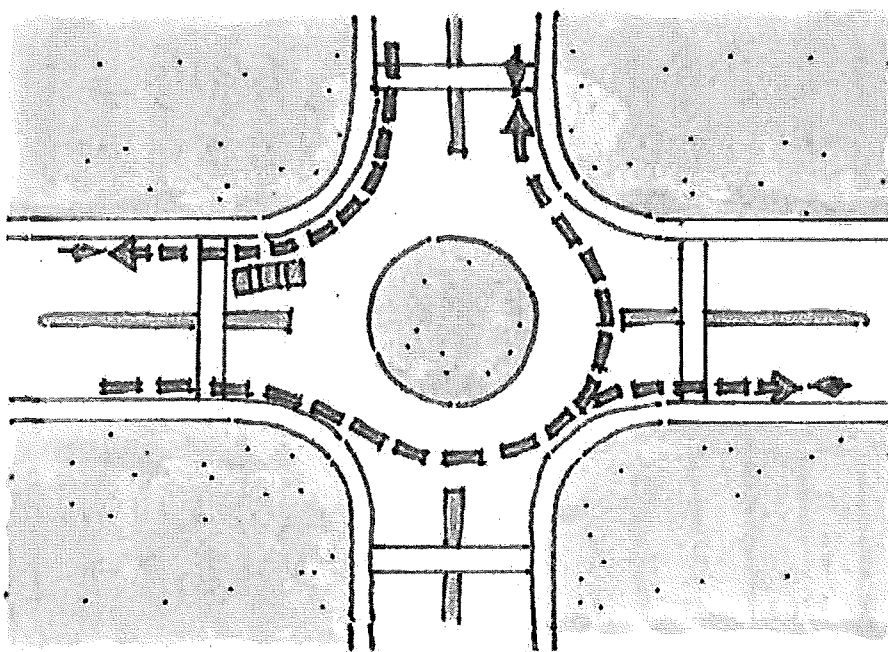

Negotiating a Roundabout

New Jersey Bicycling Manual



Sharing the Road (Adapted from the New Jersey Drivers Manual, Chapter 8)

Many Modes

Many modes of transportation are entitled to operate within most public rights-of-way in New Jersey. In addition to bicycles, there are motor vehicles of various sorts: automobiles, trucks, buses, motorcycles and mopeds (motorized bicycles); skate boards and roller blades (inline skates); pedestrians, which include persons with mobility challenges operating in wheelchairs, electric scooters and other motorized assistive devices. Additionally a device officially designated an Electric Personal Assistive Mobility Device (EPAMD), commonly referred to as a Segway, is permitted to operate in public rights-of-way. Sharing the road involves knowing and acknowledging that each of these modes may be operating in the roadway, and that they are permitted to do so provided that they operate in accordance with applicable laws.

It is important to keep in mind that you and automobiles are not the only ones using the roadways. From people to animals to other types of vehicles, it is your responsibility to know how to safely share the road with others.

Sharing the Road with Visually-Challenged Persons

Bicyclists must stop when any of the following crosses any highway or intersection: blind persons who use a predominantly white or metallic cane, blind persons accompanied by a guide dog, or a guide dog instructor engaged in instructing a guide dog.

Sharing the Road with Automobiles

Cars, trucks, buses and motorcycles must operate in accordance with New Jersey Statutes Annotated, Title 39. The operating requirements for motor vehicles are presented in the NJ Drivers Manual which may be viewed or downloaded (in English and Spanish) at:

<http://www.state.nj.us/mvc/About/manuals.htm>.

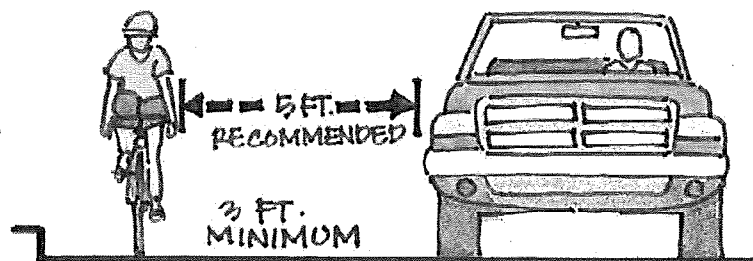

Passing a Cyclist

Sharing the road with automobiles means respecting their right to share the road with you, and operating in a focused and predictable manner. This means:

- Ride right.
- Obey all traffic signals, signs and pavement markings.
- Choose the proper lane position.
- Communicate by using an audible signal and hand signals and establishing eye contact.

New Jersey Bicycling Manual



- Be as visible as possible at night
- Don't use head phones or cell phones.
- Yield the right-of-way when appropriate.
- Be careful not to impede traffic if you are riding two abreast.

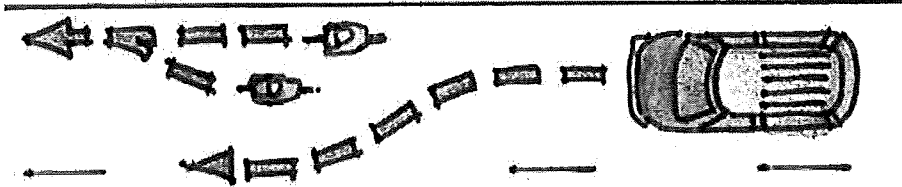

Car Passing Bicyclists/DON'T Impede Overtaking Traffic

On the other hand, motorists should respect your right to operate on the roadway and be aware of the likely and legitimate presence of bicycle traffic. This means:

- Look for bicycle traffic especially at intersections.
- Yield to bicyclists when changing lanes, turning or pulling out from a driveway.
- Refrain from blocking or parking in bike lanes.
- Refrain from using your horn to intimidate bicyclists (sudden loud blast will likely startle the cyclist and could cause them to lose control).
- Slow down and provide adequate clearance when passing a bicyclist (three feet absolute minimum at slow speeds, five feet is better, trucks, even more).
- Don't follow a bike too closely. Give bikes room to maneuver to avoid road hazards.
- Don't litter. New Jersey law makes the driver of a vehicle responsible for litter by passengers (N.J.S.A. 39:4-64).
- Avoid distractions like head phones and cell phones.
- When passing another vehicle on a two-lane road, be sure to look out for bikes coming towards you, and if you see them, yield to them, aborting the passing maneuver if need be.

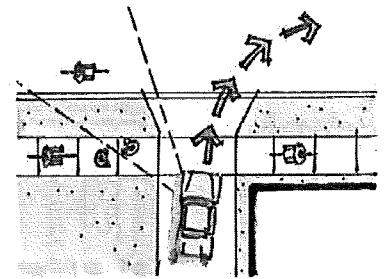

Crossing a Sidewalk

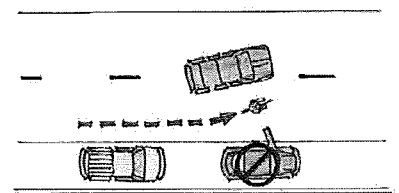

Look Before Opening Your Door

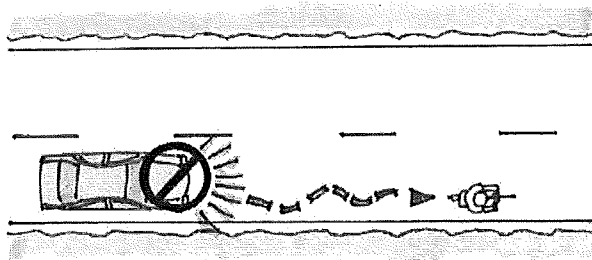

Horns DON'T Help

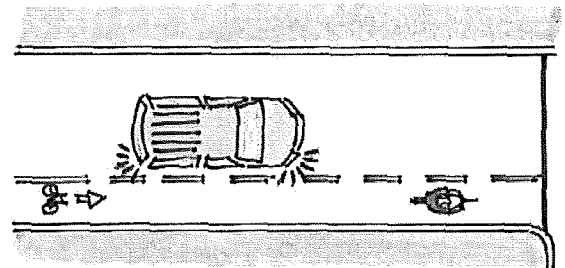

Bike Lanes are for Bikes

New Jersey Bicycling Manual



Sharing the Road with Trucks, Tractor-Trailers and Buses

Use caution when driving alongside trucks. Sharing the road with larger vehicles can be safe if you know the limitations of these vehicles regarding visibility, required stopping distance and maneuverability. When passing a large truck or bus, it is important to remember that there are several blind spots in which the driver cannot see other vehicles. In addition, during bad weather, a truck can take as much as 25 percent longer to stop.

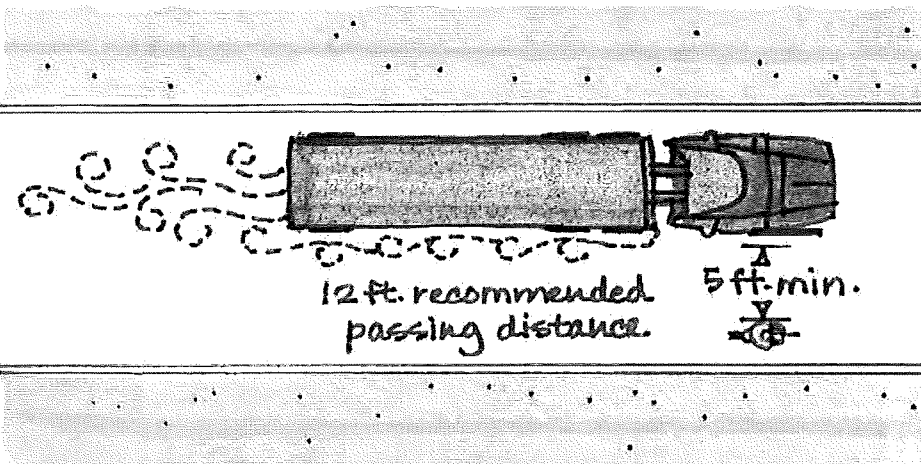

Trucks Should Give Extra Room When Passing

The New Jersey Commercial Driver Manual may be viewed or downloaded at: <http://www.state.nj.us/mvc/About/manuals.htm>, picked up at any motor vehicle agency or ordered by calling (888) 486-3339.

Sharing the Road with School and Commercial Buses

All non-emergency vehicles, including bicycles, must yield the right-of-way to buses re-entering traffic after dropping off or picking up bus passengers. However, once the bus is back in the normal flow of traffic, you are not required to yield the right-of-way to buses changing lanes. Bus operators are required to drive in a safe and responsible manner.

Sharing the Road with Motorcycles

The same laws governing other motor vehicles also govern motorcycles. However, due to the smaller size of motorcycles and their operating characteristics, extra caution should be used when sharing the road with motorcycles.

Don't follow motorcycles too closely. Be aware of slippery, sloped or uneven surfaces and grooves and gratings in the roadway. They present potential hazards for motorcycle riders. Objects on the roadway also present a challenge. Motorcyclists must be ready to react to these situations differently than motorists driving passenger vehicles. This is why it is important to leave plenty of space between yourself and a motorcycle.

New Jersey Bicycling Manual



When being passed by a motorcycle, maintain your speed and position. Allow plenty of room for the motorcycle to complete the pass and resume proper lane position.

The New Jersey Motorcycle Manual may be viewed or downloaded at: <http://www.state.nj.us/mvc/About/manuals.htm>, picked up at any motor vehicle agency or ordered by calling (888) 486-3339.

Sharing the Road with Mopeds

Motorized bicycles, or mopeds, are low-speed, two-wheeled vehicles with pedals, intended for limited use on public roadways. Moped drivers may not exceed 25 mph, must follow all traffic signs and signals and drive on the right side of the road with the flow of traffic.

Always be alert for mopeds, which are smaller than motorcycles and harder to see. Moped drivers have the same rights and responsibilities as those driving other motor vehicles.

Copies of the New Jersey Moped Manual may be viewed or downloaded at: <http://www.state.nj.us/mvc/About/manuals.htm>, picked up at any motor vehicle agency or ordered by calling (888) 486-3339.

Sharing the Road with Other Bicyclists, Skateboarders and Inline Skaters

The operator of each of these modes has the same rights and responsibilities as a driver of a motor vehicle. In general, respond to other bicycle, skateboarders and inline skaters as you would when you share the road with motor vehicles.

Sharing the Road with Individuals with Mobility-Related Disabilities

State law allows individuals with mobility-assisted disabilities to operate certain motorized scooters on public streets with a posted speed limit in excess of 25 mph but not more than 35 mph and if local government determines that the scooter does not pose a danger to safety and the flow of traffic. The motorized scooter may only have a maximum speed capability of no more than 15 mph.

The motorized scooter must be registered with the municipality in which the operator resides and must be insured. After registering the motorized scooter with the municipality, the owner may apply for a placard or sticker from the state Motor Vehicle Commission. In general, when encountering these motorized scooters on the road, respond to them as you would to other bicyclists, skateboarders and inline skaters.

New Jersey Bicycling Manual



Sharing the Road with Horseback Riders

Horse-drawn vehicles and horseback riders have the same rights and responsibilities as do motor vehicles when using public roadways. They may not use certain limited-access highways and must ride with traffic, keeping as far to the right as possible. You should approach or pass a horse or horse-drawn vehicle with care at a maximum speed of 25 mph and you must observe the request, either by hand signal or otherwise, of a person riding a horse or driving a horse-drawn vehicle in the opposite direction to stop and remain stationary for as long as it takes the horse to pass. (N.J.S.A. 39:4-72).

New Jersey Bicycling Manual



Parking Your Bike

Always secure your bike, even if you only expect to be away from it for a few minutes. It only takes a bike thief a few seconds to take it. Why take the chance?

Parking Dos and Don'ts

Do take your bike indoors where you can keep an eye on it if possible. Some parking lots and parking garages set aside a special room or guarded area for bicycle parking. Some stores and work places permit bikes to be brought inside. Even indoors, lock your bike. Even if it is at your work station, for example, there will be times when you are not present.

Do use a "case hardened" cable and chain and padlock or a "U-lock". These are commonly available. Understand that selecting a locking device will involve trade-offs. The more massive the device, the more security it is likely to provide, however, at some point it becomes too cumbersome to travel with.

Do lock your bike to a permanently fixed object, ideally to a secure bike rack or in a bike locker that has been provided for that purpose. A secure bike rack is one that allows you to put your chain, cable or u-lock through both wheels and the frame. Ideally, the rack is located under a protective shelter to protect it from inclement weather. Other options include a metal fence or utility pole.

Do make sure that you lock your bike where it can be easily seen, not hidden away in a secluded area. If given enough time, just about any locking device can be defeated. In a well observed location, a thief is unlikely to take the time to work on the locking device.

Don't just lock a wheel. This leaves the rest of the bike vulnerable, especially if your wheels are attached by "quick release" mechanisms. For extra security use two locks. Lock the frame and front wheel with one and the frame and rear wheel with the other.

Don't lock a bike to horizontal or diagonal bars on scaffolding; they can be easily unbolted.

Don't lock your bike to a parking meter with a cable or chain and padlock. The bike and cable or chain may be able to be lifted right over the meter. The same may be true of a sign post, especially if it is a shorter one. In these cases a "U-lock" may work if it fits tightly enough so that it can't be lifted over the parking meter or sign.



Bike Parked to U Racks with Cable & Padlock



Bike Locked with U-Lock

New Jersey Bicycling Manual



Don't lock your bike only to another bike, or to an object that is not massive or permanently fixed, to a post that can be pulled out of the ground or to a flimsy object that can be broken.

Don't lock your bike to a tree if there are other options. It can damage the tree.

Do make sure that the locking device is snug. That way it is more difficult for a thief to pry open the "U-lock" or place the padlock against a fixed object or the pavement to smash it open.

Do take removable equipment, such as your helmet, tools, a pump, or even your seat if it is attached by a quick release mechanism.

Do keep a record of your bike's serial number or other identifying information and a photograph of it. If there is a bike registration program in your community, register it. This will help the police identify you as the owner if they recover your bike.

Do call the police and report a stolen bike, and get a copy of the police report to document your loss for insurance purposes. If you locate or believe you have located your bike, and have kept proof of its identity, have the police take action to recover it.

New Jersey Bicycling Manual



Difficult Situations

As is the case with driving a motor vehicle, circumstances can arise when operating a bicycle that have the potential to lead to a crash and injury. The best way to minimize the risk and negative consequences associated with these situations is to know how to deal with them and put this knowledge into practice. This includes understanding the problems that may be encountered and how to avoid them, understanding safe driving practices and being able to execute emergency maneuvers.

Be Aware of and Avoid Blind Spots

While riding your bike, you may be able to clearly observe vehicles traveling in the same direction and coming toward you, but you can't assume that the drivers of those cars can see you. This is because motorists may neglect to scan or look for bicycle traffic, and because most vehicles have a natural blind spot to the driver side and passenger side rear quarter where you will not be observed in either the rear view mirror or side mirror. To avoid this situation:

- Stay far enough behind cars so you avoid being in the blind spot.
- Don't creep up and pass slower cars on the right unless you are travelling in a bike lane or the car is slowing down and signaling to make a left turn.
- Move to the left to pass a standing vehicle or one slowing and signaling to make a right turn.
- Keep in mind that there are blind spots behind vans, trucks, and buses traveling toward you. If a larger vehicle is approaching an intersection and signaling to turn left, wait until they turn and you can see that it's clear before you make a left turn.

Road Surface Hazards

Be alert to and avoid road surface hazards. They can deflect the travel path of your front wheel which will likely result in a crash. Most can be avoided by slowing down, checking for overtaking traffic and steering around or away from them. Remember, you can always stop and walk your bike past these conditions.

Road Debris - You will avoid most patches of dirt, gravel, standing water, oil spots, road hardware (drainage grates and utility covers) by assuming the proper lane position and riding several feet out from the curb or edge of pavement. If you are forced to ride through them, travel straight and don't brake. With rocks and debris such as tree branches, steer around them. Hitting them can result in a flat.

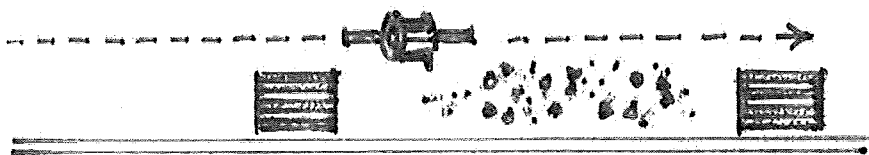

Debris Next to the Curb

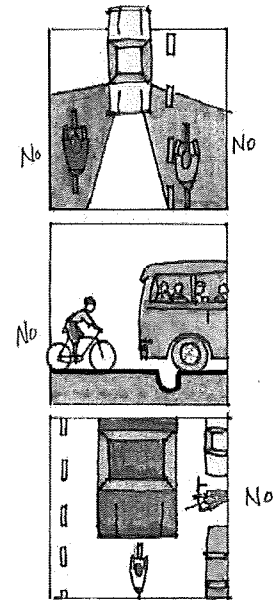

Avoid Riding in Blind Spots

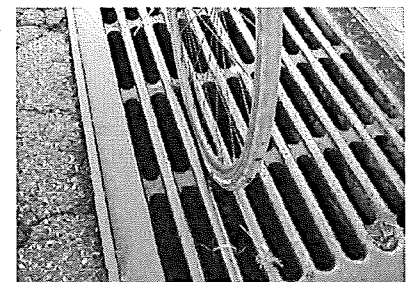

Stream Flow Grate



Debris on the Road

New Jersey Bicycling Manual



Railroad Tracks - Be cautious when encountering railroad tracks crossing the road, especially if they cross the road diagonally. Check behind and if it's clear, steer your bike so that you cross the tracks at a right angle. Trolley tracks, raised roadway reflectors, rumble strips - If these potential hazards are on the street you are riding on, stay away from them. If you must cross over them, such as when making a turn at an intersection, maneuver so as to cross them at a right angle, or as close to one as you can.

Any Wet Metal Street Hardware (Including Steel Grate Bridge Decks and Expansion Joints) - These features can be especially problematic when wet. Travel at a slow steady pace. Avoid turning, braking or accelerating. If you are not sure you can negotiate them, walk your bike.

Steel Plates or Parallel Grooves in Pavement - These features can "grab" the front wheel and cause a crash.

Puddles - It's not always possible to tell which are shallow and which cover major potholes.

Dogs

The best defense against being chased by a dog is to ride where there are well enforced "leash laws" that require dogs to be controlled on a leash if they are out of doors and not confined in a fenced in area. Fortunately most communities in New Jersey do have "leash laws" and being chased by a dog is less of a threat than it is in much of the country. Still, it happens and there are several things a bicyclist can try:

Shout - Yell something forceful such as "GO HOME"! This sometimes slows or dissuades the dog's pursuit.

Stop - If the dog is chasing for the enjoyment of the chase, it may stop if you do. If so, slowly ride or walk away.

Get Off Your Bike - If the dog continues to pursue or tries to attack, dismount and keep the bike between you and the dog. Combine this with shouting and walking away.

Use a Dog Spray - Dog spray repellent can be effective if you have the wherewithal to use it in a calm practiced manner without losing control of your bike, making sure that the wind doesn't blow the spray back into your face.

If the dog does bite you, seek medical attention as soon as you can and report the attack to the police. Try to identify the owner and have the dog confined so you may avoid having to have rabies shots.

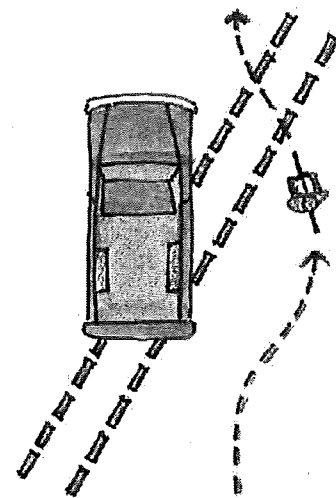

Crossing Railroad Tracks

New Jersey Bicycling Manual



Emergency Maneuvers

There will likely come a time when, despite your care and anticipation, you will encounter circumstances that require quick and decisive action to avoid or mitigate the loss of control of your bicycle and the likelihood of a crash. There are several actions that may be employed in response to these circumstances. In order to employ them to good effect, these maneuvers, like other bike riding skills, must be practiced enough so you can perform them almost instinctively.

Quick Stop - The quick stop can be used to quickly stop your bike while maintaining control, if you suddenly encounter an obstacle, or barrier that you have little or no hope of steering around. If you encounter such an obstacle, you need to simultaneously shift your weight backward by thrusting your arms forward, sliding your bottom off the saddle and over the rear wheel while at the same time applying both the front and rear brakes. The weight shift enables you to apply more braking power without the rear wheel lifting off the ground, pivoting you over the handlebars (taking a "header"). If you feel the rear wheel start to lift off the ground, immediately release pressure on the front brake. If your rear wheel starts to skid, quickly release pressure on the rear brake.

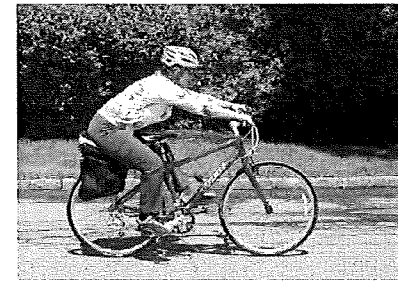

Bicyclist Executing Quick Stop



Bicyclist Executing Rock Dodge

Rock Dodge - The rock dodge will enable you to avoid smaller road hazards that you come upon suddenly or that you encounter when you don't have enough room laterally to easily steer around. As you approach the obstacle, at the last second, jerk the front wheel around the hazard then back again. By doing this, your front wheel will pass around the object. Your rear wheel will deflect less, but will probably miss the object as well. Practice this maneuver in a vacant parking lot (using a sponge, not a rock).

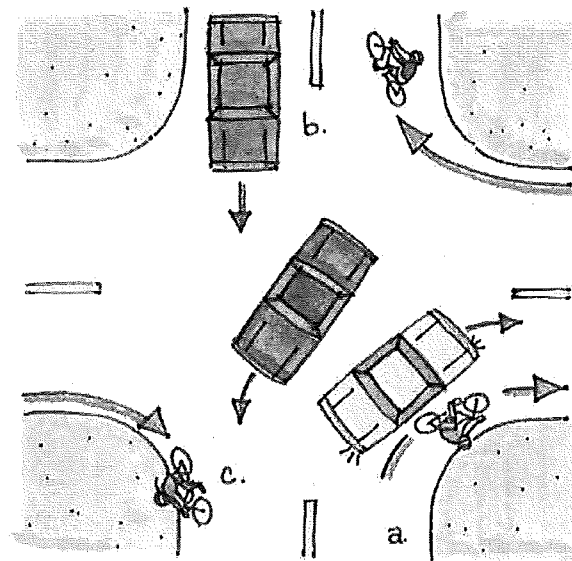

Using Quick Turn to Avoid:
a. Right Turning Car
b. Car Running Stop Sign
c. Left Turning Car

Quick Turn - This maneuver can be effective in avoiding a crash at an intersection if an approaching or overtaking vehicle suddenly turns in front of you. In such a situation you must stop, hit the car or quickly turn to the right to avoid the crash. To initiate the quick turn, quickly jerk the handlebars to the left, as you might to initiate a rock dodge. This will cause your bike to lean to the right. Immediately lean to the right, into the turn. This should enable you to quickly initiate a sharp right turn.

New Jersey Bicycling Manual



Most Frequent Types of Car-Bike Crashes According to the League of American Bicyclists

| Motorist at Fault - Top 3 | |
|---|------------------|
| Crash Type | Frequency |
| Motorist turn/merge into cyclist's path | 34% |
| Motorist driving out from a stop sign | 16% |
| Motorist exiting driveway/alley | 10% |

| Adult Cyclist at Fault - Top 3 | |
|---------------------------------------|------------------|
| Crash Type | Frequency |
| Cyclist turn/merge into motorist path | 6% |
| Cyclist overtaking motorist | 6% |
| Cyclist ride out at traffic signal | 5% |

Traffic Lights That Don't Turn

As a legal user of public rights-of way, bicyclists have a right to expect that traffic signals will work for them. Unfortunately this is not always so. Some signals work on timers, that is, each signal cycle provides a set amount of green time so that all traffic approaching or stopped at the intersection has a set amount of "green" time to pass through the intersection. Generally, this type of signal is not a problem for bicyclists, since, if they are operating as traffic on the roadway, they will automatically get an opportunity (a green signal) to proceed through the intersection.

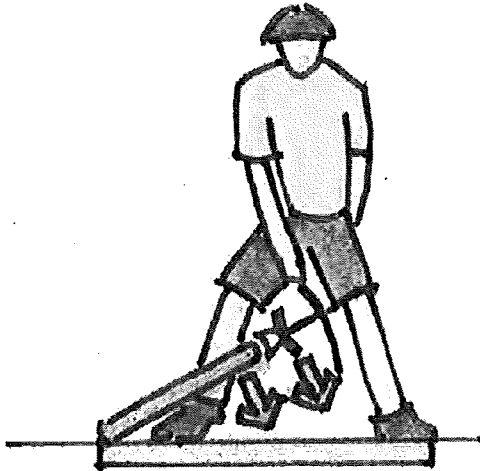

Trigger Loop Detectors

Some signals, however don't operate on timers. They won't turn green unless they receive a signal that "calls" the green phase. Traffic approaching this type of signal activates it as they are detected arriving at the intersection. They are detected by wires buried in the pavement that are sensitive to a metallic mass, or by cameras focused on the approach to the intersection that are calibrated to detect an arriving vehicle. If the wires under the pavement are arranged in certain configurations, and set so that they can detect a metal framed bicycle, and, if the bicyclist drives directly over the spot where the wires are buried or leans the bicycle over that spot, then the bike can activate the signal. In the case of video detection, if the camera is set up so that it "sees" a bicyclist arriving at the intersection, the signal will be activated.

Unfortunately this doesn't always happen. There may be no indication of where the wires are buried: or, the system may not be sensitive enough or focused to detect a bicycle; or, the bicycle frame may be made of carbon fiber. In such circumstances, the bicyclist won't get a green light and has the following options:

- *If there is a handy pedestrian push button, the bicyclist can ride or walk their bike to the pedestrian push button and activate the signal.*
- *They can wait for a car to arrive that activates the signal.*

New Jersey Bicycling Manual



If this doesn't work, the cyclist has no choice but to consider the signal defective and go through the red light. This must be done using the utmost caution to insure that there is an adequate gap in traffic, from both directions, to get through the intersection.

Conflicts with Motorists/Aggressive or Assaultive Motorists

Unfortunately, some motorists have no idea or do not accept the fact that a bicycle driver has every right to use public rights-of-way and is required to obey the traffic laws like a motorist. They may act in an aggressive or assaultive manner. They may be uncertain over what a bicyclist will do from previous experience with bicyclists who weren't predictable and did not follow the rules of the road. The best way to minimize this behavior is to:

- **Be predictable and to operate in ways that motorists would expect other road users to operate.**
- **Signal your intentions and ride where traffic can see you.**

For simple, minor or brief verbal harassment, such as someone shouting "get off the road", the best thing to do is to keep hold of your temper. If you don't, the situation could escalate. If the behavior is more aggressive, such as shouting threats, continuing harassment, trying to touch you as they pass, riding up close behind you or cutting you off, it's still best to refrain from responding if you can. Don't get involved in a shouting match and by all means don't get into a physical confrontation. Remember, they are surrounded by two tons of metal, you're not. If a disgruntled motorist doesn't attack you, they just might take their anger out on the next cyclists they see. These more serious threats should be reported to the police.

- *If you have a cell phone with you, stop and call 911.*
- *If you have a camera, take pictures.*
- *Record the license plate number and the type of vehicle, where and when it happened.*
- *Courteously assert your rights and follow up with law enforcement officials until the matter is handled to your satisfaction.*

The New Jersey Department of Transportation and the Department of Law and Public Safety are committed to see that the traffic laws are enforced for both bicyclists and motorists, that the travelling public is educated about the rights of bicyclists to use public rights-of-way and the obligations bicyclists have to ride in accordance with the rules of the road.

New Jersey Bicycling Manual



If You Are Involved In a Crash

- *Check for injuries; if you or others are injured, call for help from police and emergency services if you are able.*
- *If you are injured, don't move until you are sure you will not be exacerbating your injuries.*
- *Even if you don't think you are injured, get medical attention. Documentation of injuries may be important for insurance purposes. You may not be aware you have been injured. Some injuries aren't apparent immediately.*
- *Administer first aid to others if you can and are trained to do so.*
- *Don't discuss fault.*
- *As soon as you can, write down the following information:*
 - *Location and time of the crash*
 - *Descriptions of vehicles involved including license plate numbers*
 - *Driver's description and driver's license information*
 - *Driver's insurance information*
 - *Description of the crash including a diagram, weather and light conditions, road surface conditions*
 - *Witness Information, including name and phone numbers (same for passengers)*
- *Take photos of any damages you and your property have sustained.*
- *File a police report.*



Riding at Night & in Rain and Snow

Riding at Night

Cyclists should exercise extra caution when riding at night and ride defensively. Use front and rear lights as required by law and never assume a motorist can see you. You should also consider wearing light colors or reflective clothing.

What the Law Requires - When in use at nighttime every bicycle shall be equipped with: 1) A front headlamp emitting a white light visible from a distance of at least 500 feet to the front; 2) A rear lamp emitting a red light visible from a distance of at least 500 feet to the rear; 3) In addition to the red lamp a red reflector may be mounted on the rear.

About Lights - The main purpose for lights is to help other drivers see you. Most lighting systems don't do a great job lighting the road ahead of you. If you know that you will be riding at night, don't ride on roads that you know have debris or poor surface conditions. Most generator powered lights have the disadvantage of going out when you stop. If you intend to use generator powered lights, get a model that has a battery back-up that keeps the light on when you stop. Bright high powered rechargeable battery powered lights are the best; however they are expensive, and heavy. Make sure they are fully charged when you set out as they use up the battery quickly. If you find yourself out riding, having no lights on your bike, and it starts to get dark, you might try affixing a flashlight on your handle bars facing on-coming traffic. Carry a spare bulb and battery.

What Else You Can to Do To Be Seen

- *Use a flashing red LED rear facing light; they are more visible than a steady red light*
- *Wear light colored clothing*
- *Wear a safety vest or jacket with reflective material*
- *Wear a pants strap with reflective material*
- *Use spoke reflectors on your bike*
- *Use pedal reflectors on your bike*
- *Wear a strobe light on your arm (affixed by an arm band)*
- *Use a red reflector facing to the rear to supplement the red rear light*
- *Use a white reflector facing front to supplement the white front facing light*
- *Supplement the front and rear reflectors with an amber reflector*
- *Choose routes you are familiar with to minimize threats to your personal security*
- *Ride slower than you would during daylight*
- *Don't drive under the influence of alcohol or drugs*

New Jersey Bicycling Manual



Riding in Rain and Snow

It is easier to ride in inclement weather if you have the proper clothing for the situation. Understanding how these conditions affect your driving (and other drivers) and driving your bike in a way that minimizes the effect of those conditions are also important considerations.

Dress for Success - As the old saying goes: there is no bad bicycling weather, just bad clothes for bicycling. There is a plethora of clothing available that is designed specifically for bicycling in wet and cold weather.

- *In wet weather you need a garment to keep from getting soaked, but while you want to keep the rain out, you don't want to keep the perspiration in. A poncho, which lets air in (and moisture from perspiration out) from the bottom, or a breathable and vented rain proof jacket with a hood will keep you reasonably dry.*
- *Keep hoods fastened tightly around your face so as not to block your vision.*
- *Waterproof rain pants or gaiters will keep your legs dry. Remember: fenders keep water from being thrown up onto you and anything you might be carrying.*
- *In cold weather, you need to dress in layers and, depending on the severity of the cold, cover exposed skin.*
- *Since cycling requires an expenditure of energy and generates heat, you may not need as much clothing as you might think. By dressing in layers, you can shed layers to prevent overheating.*
- *Next to the skin wear a layer that will wick away moisture.*
- *There are no set rules. Experiment with different combinations to find out what is comfortable under varying temperatures. There are many options, including long sleeve cycling shirts, thermal undershirts, long johns, tights, full fingered gloves of various thicknesses, mittens scarves, turtlenecks, balaclavas, gaiters, wool socks or socks that wick moisture, shoe covers (booties) and ski masks that can be used to cover exposed skin and keep you warm and dry.*
- *Try to pick clothes that are brightly colored and have reflective attributes; or, add reflective patches or tape.*

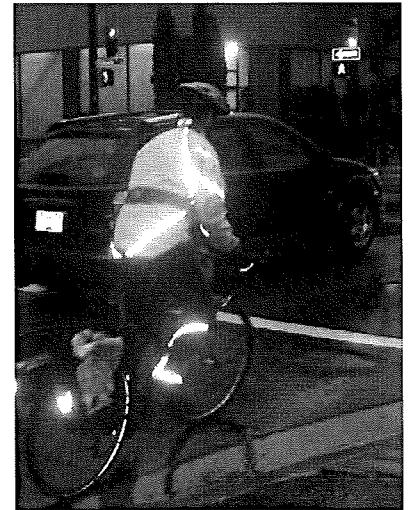

Rider Dressed for Rain

Wet and snowy conditions pose special operational challenges you need to deal with.

- *Rain and snow limit visibility or may obscure road conditions, so slow down.*
- *Debris (especially wet leaves) and street hardware like drainage grates and manhole covers can be especially slippery, so be cautious and avoid them if you can. The same is especially true of metal grate bridges. Walk your bike over or around if you must.*
- *Don't ride through puddles or standing water. They may be hiding a pot hole in which case of you do ride through it; you are likely to crash or damage your bike...or both!*

New Jersey Bicycling Manual



- *Remember, the road surface may be slippery, too, especially just after it begins to rain as oil on the pavement is lifted off the surface, so don't apply brakes or swerve suddenly to avoid road hazards.*
- *Wet brake pads and rims can drastically reduce your ability to slow down and stop. Go slower and apply brakes earlier than you would under dry conditions.*
- *Avoid riding in snowy conditions if possible. Ride on streets that have been cleared of snow. Snow, while slippery itself, may be covering ice, so don't ride over patches of snow.*
- *If snow is plowed onto the shoulder or edge of pavement, you will have to ride further out towards the center of the lane. While you have the right to do this, it may put you into conflict situations with motorists, who are also likely experiencing difficulties.*
- *Wet weather, especially salty water, can be hard on your bike. When you reach your destination, store your bike in a dry place where it can dry out; wipe it dry if possible.*

New Jersey Bicycling Manual



Riding with Others

One of the reasons people choose to bicycle is because it is fun. Bicycling with others can enhance your enjoyment. Camaraderie, socializing, getting encouragement, learning skills and achieving a measure of security are all reasons why folks choose to bike with others, whether with a large group for an event or charity fund-raising ride, a few fellow club cyclists or one or two riding partners. However, bike crashes aren't fun. Some common sense behavior can lessen the potential for bike/bike crashes and other potential problems associated with riding with others.

Riding Single File

New Jersey Law allows bicyclists to ride side by side but no more than two abreast. If overtaking traffic doesn't have room to pass, then bicyclists must ride single file. Unfortunately, it is all too common to see groups of cyclists spread all over the road. This gives bicyclists a reputation, at the very least of being inconsiderate or worse, hazards and lawbreakers, and this reputation spreads to cover all riders, law abiding or not. If there is any question about whether you are impeding traffic, it's best to play it safe and ride single file.

Communicate

Communicate roadway conditions in front of you by calling out to those following and pointing at debris, potholes and other conditions to be avoided. Communicate to those ahead of you that there is overtaking traffic by calling out "car back." This warns riders ahead that it is time to return to single file if they are riding two abreast. When you plan to pass another cyclist, first check for overtaking traffic and if it is clear, call out "on your left" as you proceed to pass. Anticipate that other riders in a group may be passing you, so be careful to ride in a straight steady manner and don't suddenly veer out.

Don't Follow the Herd

When you ride in a group, you must exercise caution and care and obey the rules of the road for yourself. The group does not confer a right to suspend the requirements of the law and safe cycling practices. You still need to observe speed limits and traffic controls, yield the right-of-way when required to do so and signal your intentions before you move out to pass, turn or stop. Just because someone riding ahead of you does something, it doesn't mean it is safe for you to do it as well. Don't yell "clear" at intersections. It may be clear for that cyclist but not for those behind. Cyclists must develop the habit of checking conditions at intersections for themselves rather than trusting someone else's judgement.



Riding on Shared-Use Paths (Multi-Use Paths or Trails)

As noted elsewhere in this manual, the vast majority of bicycling, whether for recreation or personal transportation, takes place on our roadways and the main purpose of this manual is to provide the knowledge and skills required to ride on roadways with other traffic. Understanding the information contained in the manual along with practicing bike riding skills will enable you to ride with competence and confidence.

A well planned and well designed shared-use path should mitigate some of the problems associated with sidewalks for bicycle riding. However, trails should be used with caution, because collisions happen more frequently on paths than on streets. Shared-use paths should be at least 10 feet wide with two feet of clear space on either side. If they are narrower, maneuvering around other path users can be problematic. Keep in mind, multi-use trails do eventually intersect with roadways; the more roadways they cross, the more potential conflicts with motor vehicle traffic.

Here are some tips that should be followed when riding on shared-use paths:

Be Alert, Courteous, Cautious and Forgiving - Many people, including children, are unsure of how to operate on trails and are not skillful bicyclists. They may wander back and forth across the trail, seemingly unaware that they have obligations to other trail users. They may not know what side of the trail to ride on or how to pass. Don't assume that everyone riding on a shared-use path understands the rules or has the skills to operate effectively. Just like riding on the road, you must be cautious, drive defensively, and show patience and tolerance. Don't speed.

Ride Right - All shared-use path users should travel on the right and pass on the left.

Don't Stop on the Trail - Pull off the trail when you stop. If you stop on the trail, you become an obstacle to others. You could be struck by other bicyclists or force them to veer around you, which could result in their loss of control, swerving off the trail and crashing or colliding with others.



Mix Traffic on Shared-Use Path

New Jersey Bicycling Manual



Share the Trail - When you ride on a multi-use trail you should expect to encounter other types of users: pedestrians (including those in wheelchairs or using other mobility assistive devices), other bicyclists, rollerbladers, skateboarders and possibly, equestrians. You are obliged to yield the right-of-way to equestrians and pedestrians. You shouldn't assume that other bicyclists will yield to you when they should. You should also be aware that you may encounter motor vehicles wherever the trail crosses roadways or driveways.

Communicate with Others When you Pass - Don't pass unless you can see your way clear to do so. As you would when riding on the road, check behind you for overtaking traffic. Check ahead of you for oncoming traffic. Use your bell or audible warning signal and call out "passing on your left" or "on your left," then proceed to pass. Give those you are passing adequate clearance.

Crossing Intersecting Roads or Other Trails - When approaching an intersection with a roadway or another trail, obey whatever traffic control devices are present. If there are none, yield to other traffic arriving at the intersection before you. Even if you arrive at the intersection first, be prepared to stop, especially at a road crossing since most motorists may assume they have the right-of-way over trail users.

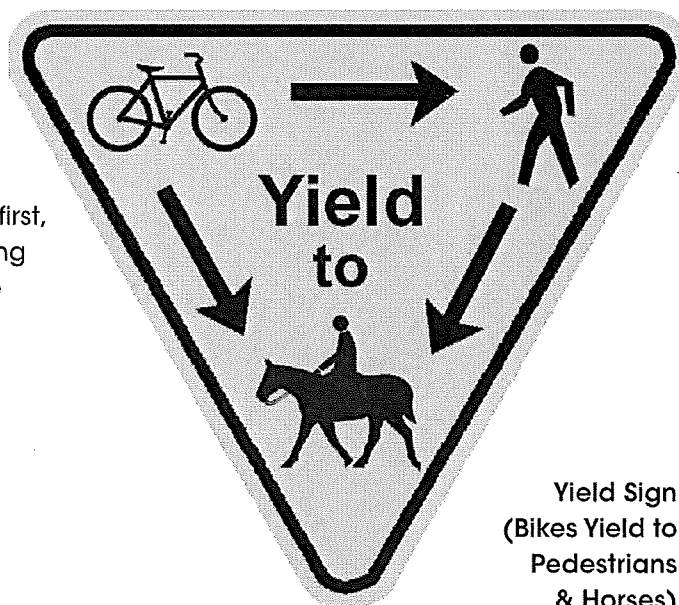

New Jersey Bicycling Manual



New Jersey Bicycling Law & Roadway Restrictions

Required Equipment

39:4-14.5 Definition. "Bicycle" means any two wheeled vehicle having a rear drive which is solely human powered and having a seat height of 25 inches or greater when the seat is in the lowest adjustable position.

39:4-10 Lights on Bicycles. When in use at nighttime every bicycle shall be equipped with: 1) A front headlamp emitting a white light visible from a distance of at least 500 feet to the front; 2) A rear lamp emitting a red light visible from a distance of at least 500 feet to the rear; 3) In addition to the red lamp, a red reflector may be mounted on the rear.

39:4-11 Audible Signal. A bicycle must be equipped with a bell or other audible device that can be heard at least 100 feet away - NOT a siren or whistle.

39:4-11.1 Brakes. A bicycle must be equipped with a brake that can make wheels skid while stopping on dry, level, clean pavement.

Rights and Duties

39:4-14.1 Rights and Duties of Persons on Bicycles. Every person riding a bicycle on a roadway is granted all the rights and subject to all of the duties of the motor vehicle driver.

On August 1, 1998 this law was extended to include roller and inline skates and skateboards. Roller skates means a pair of devices worn on the feet with a set of wheels attached, regardless of the number or placement of those wheels that are used to glide or propel the user over the ground.

Operating Requirements

39:4-12 Feet and Hands on Pedals and Handlebars; Carrying Another Person. DO NOT drive the bicycle with feet removed from the pedals, or with both hands removed from the handlebars, nor practice any trick or fancy driving on a street. Limit passengers to only the number the bicycle is designed and equipped to carry (the number of seats it has).

39:4-14 Hitching on Vehicle Prohibited. No person riding a bicycle shall attach themselves to any streetcar or vehicle.

39:4-14.2, 39:4-10.11 Operating Regulations. Every person riding a bicycle on a roadway shall ride as near to the right roadside as practicable, exercising due care when passing a standing vehicle or one proceeding in the same direction. A bicyclist may move left under any of the following conditions: 1) To make a left turn from a left turn lane or pocket; 2) To avoid debris, drains, or other hazardous conditions on the right; 3) To pass a slower moving vehicle; 4) To occupy any available lane when traveling at the same speed as other traffic;

New Jersey Bicycling Manual



5) To travel no more than two abreast when traffic is not impeded, but otherwise ride in single file. Every person riding a bicycle should ride in the same direction as vehicular traffic.

In New Jersey, the law states that a bicyclist must obey all state and local automobile driving laws. A parent may be held responsible for the child's violation of any traffic law.

New Jersey's Mandatory Helmet Law

Title 39:4-10.1 In New Jersey, anyone under 17 years of age that rides a bicycle or is a passenger on a bicycle, or is towed as a passenger by a bicycle must wear a safety helmet.

On August 1, 1998 this law was extended to include roller and inline skates and skateboards. Roller skates means a pair of devices worn on the feet with a set of wheels attached, regardless of the number or placement of those wheels that are used to glide or propel the user over the ground.

On January 8, 2000 the helmet legislation was extended further to include requirements for operators of an Electric Personal Assistive Mobility Device (EPAMD).

The definition of bicycle with reference to the helmet legislation is a vehicle with two wheels propelled solely by human power and having pedals, handle bars and a saddle-like seat. The term shall include a bicycle for two or more persons having seats and corresponding pedals arranged in tandem.

All helmets must be properly fastened and fitted. Bicycle helmets must meet the federal standards developed by the Consumer Product Safety Commission (CPSC) effective March 10, 1999 that ensure the best head protection and strong chin straps to keep the helmet in place during a fall or collision. Also acceptable are helmets meeting the Snell Memorial Foundation's 1990 Standard for Protection Headgear.

Exemptions from the helmet requirement are persons who operate or ride a bicycle (as a driver or a passenger) on a roadway closed to motor traffic; on a trail, route, course, boardwalk, path or area set aside only for the use of bicycles. These exemptions do not apply if the areas of operation are adjacent to a roadway and not separated from motor vehicle traffic by a barrier that prevents the bicycle from entering the roadway. Bicyclists or passengers operating in an area where helmets are not required who need to cross a road or highway should walk with the bicycle.

Initial violators of the helmet law will receive warnings. For minors, the parent or legal guardian may be fined a maximum of \$25 for the 1st offense and a maximum of \$100 for subsequent offense(s), if lack of parental supervision contributed to the offense.

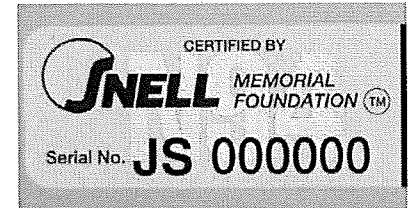

Snell Memorial Foundation
Certification Stickers

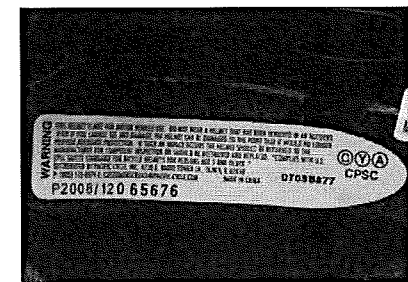

CPSC
Certification Sticker

New Jersey Bicycling Manual



Bicycle salespersons and rental agents must display a sign at least 15 inches long and 8 inches wide at the point where the transaction is completed when they sell or rent a bicycle. This sign should read: "STATE LAW REQUIRES A BICYCLE RIDER UNDER 17 YEARS OF AGE TO WEAR A HELMET." In the case of bicycle rentals, the salesperson/rental agent must provide a helmet, if necessary, for a fee.

Highway Restrictions

Bicycle traffic is restricted by regulations on the following roads. These are the only roadways for which access restrictions for bicycle traffic have been officially publicized.

| <u>Roadway</u> | <u>Location</u> |
|--------------------------|---|
| Garden State Parkway | Entire length |
| New Jersey Turnpike | Entire length |
| Atlantic City Expressway | Entire length |
| Route 1 Freeway | Trenton, Mercer County |
| Route 18 Freeway | Wall, Ocean County, Neptune City, Tinton Falls, Colts Neck, Freehold, and Marlboro, Monmouth County, Old Bridge, Middlesex County |
| Route 29 Freeway | Trenton, Mercer County |
| Route 52 | Somers Point, Atlantic County, Ocean City, Cape May County |
| Route 208 Freeway | Fair Lawn, Glen Rock, Franklin Lakes, Wycoff and Oakland, Bergen County, Hawthorne Borough, Passaic County |
| Route 42 Freeway | Washington Township and Deptford, Gloucester County, Runnemede, Gloucester Township and Bellmawr, Camden County |
| Interstates | Various locations |

New Jersey Bicycling Manual



Note: In New Jersey, interstate roadways are currently closed to bicyclists; however, most sections are open by special permit issued by NJDOT.

For a permit to ride on these sections write to:

Bicycle/Pedestrian Coordinator
New Jersey Department of Transportation
1035 Parkway Avenue, PO Box 600
Trenton, NJ 08625-0600

A Word about Pedestrians

The proportion of pedestrians injured and killed in crashes is high in New Jersey compared to the nation as a whole. The most important pedestrian safety message for New Jersey residents is: Pedestrian Safety Is a Shared Responsibility. Pedestrians, bicyclists and motorists must all do their part to keep pedestrians safe.

Pedestrian activity is at its greatest in densely developed areas, such as cities and town centers, but it is also significant in neighborhoods and along and across suburban roadways. Drivers should take special precautions to watch for pedestrians.

In most cases, pedestrians have the right-of-way at all intersections. There is a crosswalk at every intersection, even if it is not painted as such. This is known as an "unmarked crosswalk." A motorist must stop and remain stopped for a pedestrian who is crossing at a crosswalk (marked or unmarked) until the pedestrian completes his/her crossing, unless traveling along the half of the roadway on the other side of a safety island from the pedestrian.

Drivers are prohibited from blocking the crosswalk when stopped at a red light or stop sign. A driver must not stop with a portion of his/her bicycle or motor vehicle in the crosswalk area. When the crosswalk is blocked, it forces pedestrians to go around, outside the crosswalk, putting them in danger. Never pass a vehicle stopped at a crosswalk (N.J.S.A. 39:4-36). This could result in a severe injury or death to pedestrians.

Watch for signs that mark special hazard areas, such as school zones, bus stops, playgrounds, parks and schools, where children are most likely to play or cross the streets. Children chasing a ball, for instance, give no thought to traffic. Small children are hard to see. Always watch for movement around parked vehicles.

Drive cautiously along roadways with on-street parking, as pedestrians may appear from between parked vehicles. Traveling at lower speeds will give one a greater ability to stop and avoid potential conflicts with pedestrians. At night, watch for anyone walking along a highway and exercise due caution.

New Jersey Bicycling Manual



In sum, a bicyclist must:

- *Yield to pedestrians in crosswalks, both marked and unmarked. (Per N.J.S.A. 39:4-36, failure to yield carries a \$100 fine, up to 15 days in jail and a 2-point license penalty.)*
- *Watch for pedestrians when turning right on red.*
- *Obey speed limits.*
- *Be sure not to block or park in crosswalks.*
- *Be alert for pedestrians at all times.*
- *Be aware of areas where pedestrians are most likely to appear (near schools, town centers, residential neighborhoods, parks).*
- *Never pass another vehicle that has stopped to yield to a pedestrian.*
- *Yield the right-of-way to all pedestrians in a crosswalk, even if they began crossing with a proper signal and they are still in the crosswalk when the signal changes.*
- *Remember that pedestrians are the most vulnerable roadway users, and like motorists, bicyclists will be held responsible for maintaining pedestrian safety.*
- *Be extra careful at intersections, especially when making an allowed right turn on red.*
- *Be alert for pedestrians when making turns and entering or exiting driveways, parking lots and alleys.*

A Word about Intersections

An intersection is where two or more roads cross or merge at angles. As most collisions occur at intersections, a bicyclist should be aware of the three types of intersections and know how to safely navigate through them. A single solid white line across a road at an intersection means that a bicyclist must stop behind the line for a traffic signal or sign.

Controlled - An intersection is controlled if there are traffic signals or signs in any direction. A bicyclist must obey the signals and signs. At a controlled intersection, a bicyclist must yield for certain conditions. At a multi-way stop or stop intersection, a bicyclist must yield to the traffic on the right if both get there at the same time. A bicyclist should also yield to another driver already stopped at the intersection. At an intersection controlled by a yield sign, a bicyclist must slow down and yield to traffic on the intersecting roadway, even if he/she has to stop. When making a left turn at an intersection, a bicyclist must yield to oncoming traffic and to pedestrians within the crosswalk.

Note: Driving on private property to avoid a traffic signal or sign is a motor vehicle violation. (N.J.S.A.39:4-66.2)

Uncontrolled - An intersection is uncontrolled when two or more roads join and there is no traffic signal or regulatory device. A bicyclist must be very careful when approaching these types of intersections. Most of the time there will be a warning sign prior to reaching the intersection. As a

New Jersey Bicycling Manual



bicyclist nears a crossroad that is not controlled, he/she must reduce speed and be ready to stop if any traffic is coming from the right or left. A bicyclist coming from a private road or driveway must yield to all traffic on the main road (although a bicyclist can never be sure that will occur). As a general rule, the vehicle on the left should yield to the vehicle on the right. When a traffic signal is not illuminated because of a power failure or other malfunction, the traffic signal is observed as a 4-way stop signal. (N.J.S.A. 39:4-81)

Blind - Buildings, parked vehicles or landscaping may obstruct a bicyclist's line of sight. On rural roadways, trees, crops or other vegetation may obstruct a bicyclist's line of sight. A bicyclist should always slow down or stop completely to make sure there is no cross traffic before proceeding.

New Jersey Bicycling Manual



Traffic Signals, Signs and Road Markings

Traffic signals, signs and road markings are set up to control the flow of traffic, making streets and highways safer for motorists, bicyclists and pedestrians. Bicyclists are required to obey all traffic signals, signs and road markings. During heavy traffic or in an emergency, a police officer may direct traffic. A police officer can overrule traffic signals. Law enforcement orders or directions must always be obeyed.

Traffic Signals

When traffic signals are hung vertically, the red light is always on top. The yellow is in the center. The green light is third in line. If there is a green arrow, it is always on the bottom. When the lights are horizontal, red is always on the left.

Red Light - A bicyclist must stop before the intersection or crosswalk and remain stopped until the light changes to green.

Yellow Light - A bicyclist should stop before entering the intersection or crosswalk, unless his/her bicycle is so close to the intersection that it cannot be stopped safely. A yellow arrow means the signal is changing from green to red and gives the bicyclist a chance to stop safely.

Green Light - A bicyclist should proceed through the intersection. Yield to pedestrians and vehicles still in the intersection and when turning left or right. Before making a left turn, yield to approaching vehicles.

Green Arrow - When shown alone or in combination with the red signal, proceed only as shown by the arrow. Be cautious and yield to pedestrians.

Flashing Yellow Light - Slow down and proceed with care.

Flashing Red Light - Stop. Yield to traffic and pedestrians. Go only when safe.

Unlit Signal - Stop if a signal does not have any of its bulbs working and no one is directing traffic. Look left and right. Yield to traffic coming from the right or left. Be careful and go only when safe.

Traffic Signs

Signs are divided into three basic categories:

- *Warning: Warn bicyclists of hazards ahead that are difficult to see.*
- *Guidance: Guide bicyclists to a destination by clearly identifying the route.*
- *Regulatory: Regulate traffic speed and movement.*

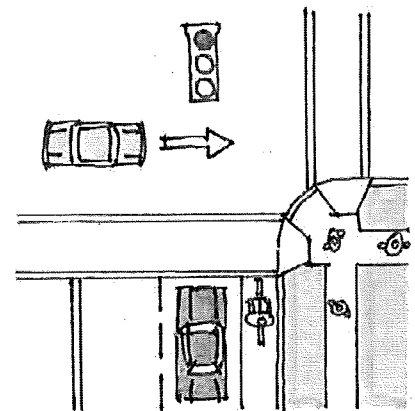

Stop at Red Lights
& Stop Signs

New Jersey Bicycling Manual



Warning Signs

Warning signs are for road conditions that need caution and for specific hazards that may be encountered during certain road operations. Some of the warning signs alert bicyclists to road conditions, school crossings or curved roadways. The signs are yellow and diamond-shaped with a black symbol or word message.

Road Work Signs (A subset of Warning Signs)

Road work signs on an orange diamond background alert drivers to a variety of temporary roadway conditions.

It is important to look for:

- *Orange, diamond-shaped signs that warn the bicyclist of lane closings, lane shifts, flaggers, uneven pavement and detours. Road work may temporarily close lanes or divert them, changing traffic patterns.*
- *Reduced speed limit signs that are posted alongside orange work zone signs. In New Jersey, all traffic fines are doubled in work zones.*

A bicyclist should react to road work signs by:

- *Controlling the distance between his/her vehicle and the one in front, as well as his/her reaction time. Always read the signs, follow directions and prepare to slow down or stop.*
- *Staying alert to the moving construction machinery in the work zone. With patience, a bicyclist will contribute to the overall safety of other road users and workers in the work zone.*
- *Watching for workers on the road, who risk injury, possibly death. Flaggers may stop and release traffic through the work zone. Note that flaggers have the same authority as a regulatory sign, so a bicyclist may be cited if he/she disobeys their directions.*

Guidance Signs

Guidance signs provide information about destinations and routes. These include, for example, U.S., state, county & interstate route markers.

Service Signs

A type of guidance sign, service signs have white letters or symbols on a blue background and provide information about services.

Regulatory Signs

Regulatory signs are generally rectangular, with the longer vertical dimension, and have black wording and borders on a white background. Some important regulatory signs to know are:

- **STOP:** *Octagonal sign with white wording and border on red background*
- **YIELD:** *White inverted triangle with red wording and border with a white border band*

New Jersey Bicycling Manual



- **DO NOT ENTER:** *White square with a red circle that has a white band horizontally across the center of the circle and the words "DO NOT ENTER" in white letters on the upper and lower parts of the circle.*

Traffic signals, signs and road markings are set up to control the flow of traffic, making streets and highways safer for motorists, bicyclists and pedestrians. Bicyclists are required to obey all traffic signals, signs and road markings. During heavy traffic or in an emergency, a police officer may direct traffic. A police officer can overrule traffic signals. Law enforcement orders or directions must always be obeyed. Appendix B contains information about the traffic control devices you should be familiar with (N.J.S.A. 39:4-14.1).

New Jersey Bicycling Manual



Regulatory Signs for Bicycle Facilities

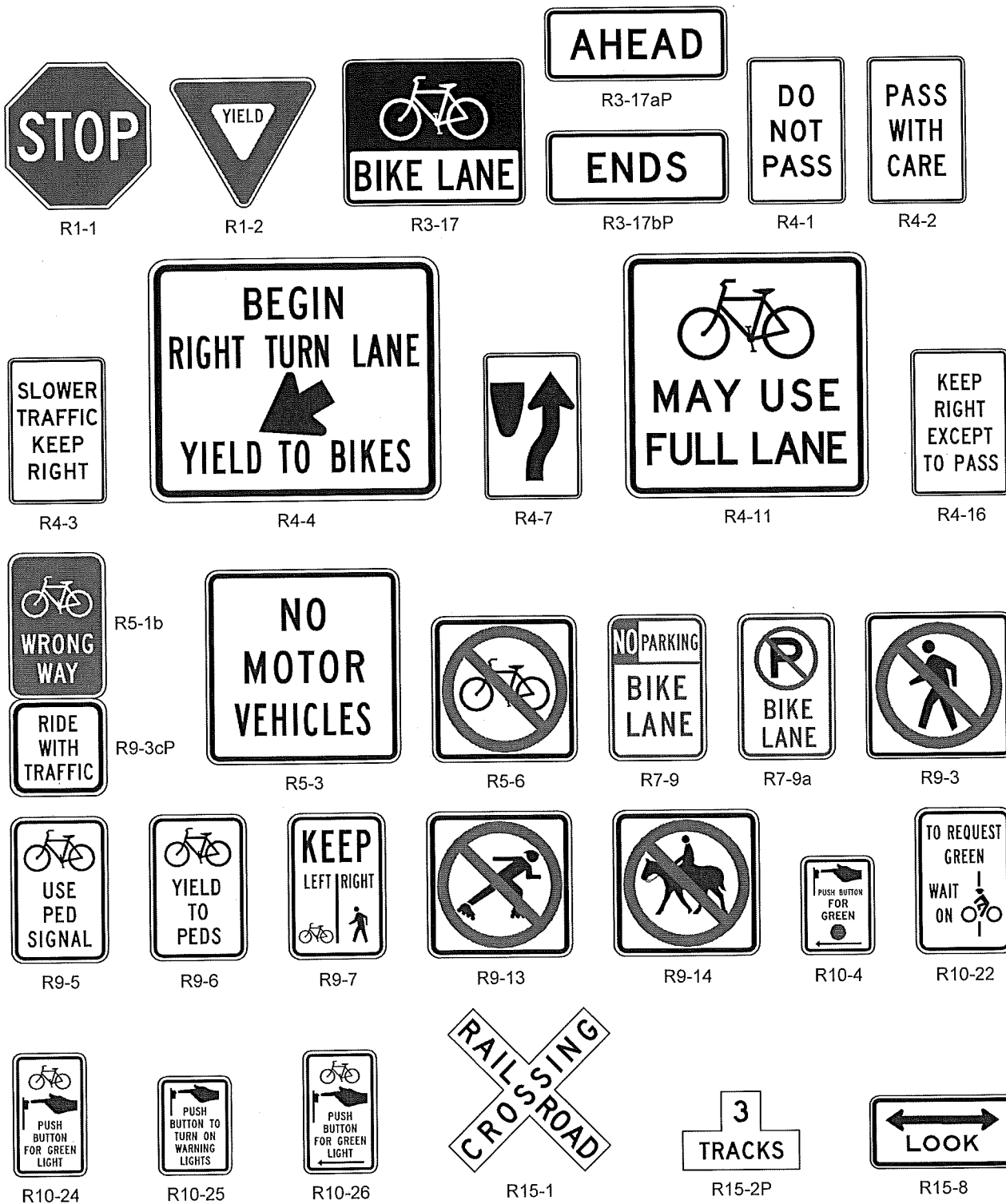

New Jersey Bicycling Manual



Warning Signs for Bicycle Facilities



W1-1



W1-2



W1-3



W1-4



W1-5

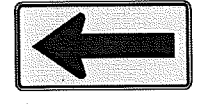

W1-6

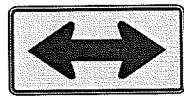

W1-7



W2-1



W2-2

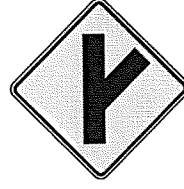

W2-3

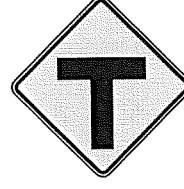

W2-4



W2-5

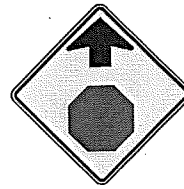

W3-1

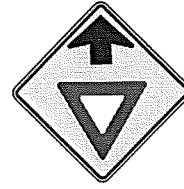

W3-2

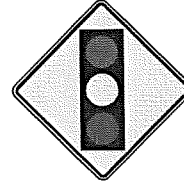

W3-3



W5-2



W5-4a



W7-5



W8-1



W8-2



W8-3



W8-10



W8-10P

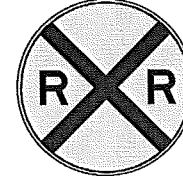

W10-1



W10-9P

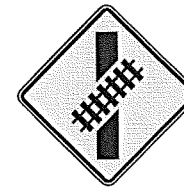

W10-12

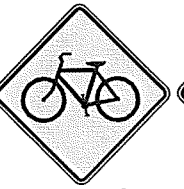

W11-1*



W11-2*



W11-15*



W11-15P*



W12-2

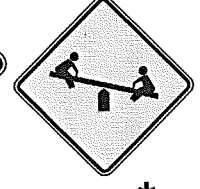

W15-1*



W16-1P*



W16-2P*



W16-2aP*



W16-7P*



W16-9P*



OM3-L



OM3-C



OM3-R

* A fluorescent yellow-green background color may be used for this sign or plaque. The background color of the plaque should match the color of the warning sign that it supplements.

New Jersey Bicycling Manual



Guide Signs for Bicycle Facilities



D1-1



D1-1a



D1-1b



D1-1c

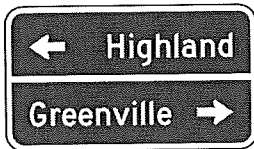

D1-2

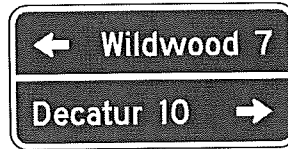

D1-2a



D1-2b

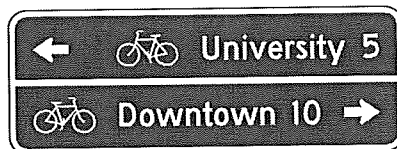

D1-2c

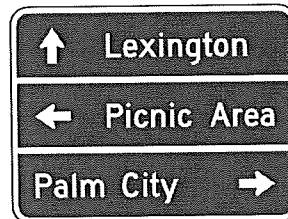

D1-3

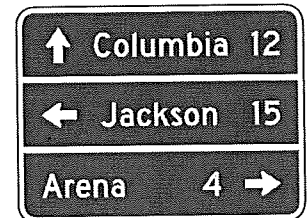

D1-3a

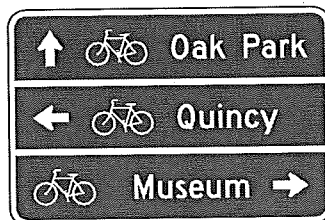

D1-3b

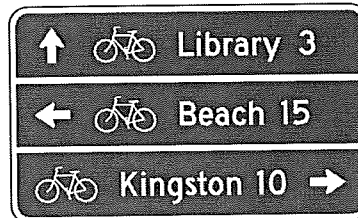

D1-3c



D3-1



D4-3



D10-1



D10-1a



D10-2



D10-2a



D10-3



D10-3a

New Jersey Bicycling Manual



Pavement Markings for Bicycle Facilities

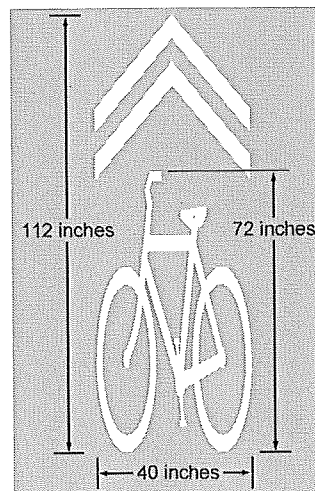
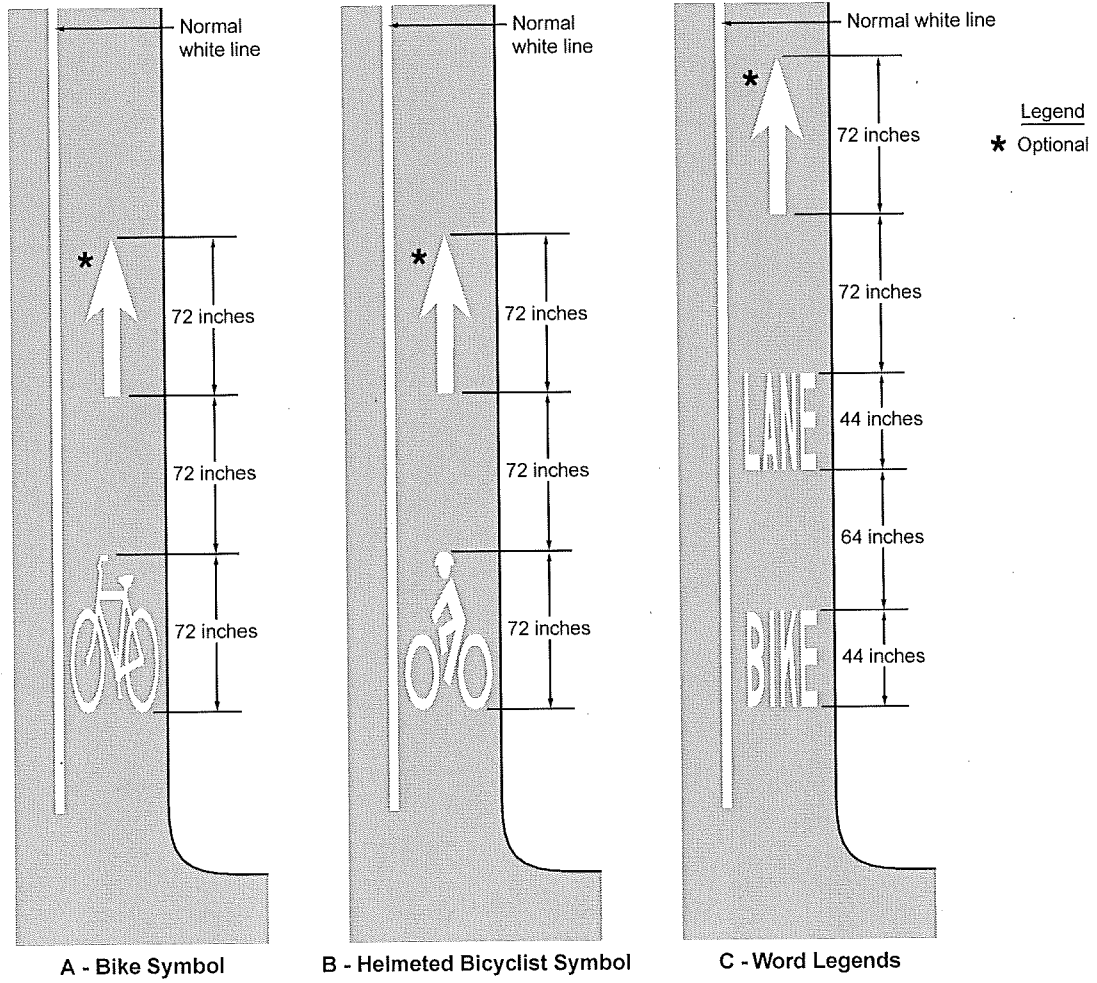

Shared Lane Marking